

PUBLICATION NUMBER MR-04459  
April 26, 1996



# SM SERIES PUMPS SM4K

All Materials And Voltages

**MANUAL  
PART 3 of 3**

**MAINTENANCE  
AND  
REPAIR  
WITH  
TROUBLESHOOTING**

**THE GORMAN-RUPP COMPANY • MANSFIELD, OHIO**

**GORMAN-RUPP OF CANADA LIMITED • ST. THOMAS, ONTARIO, CANADA** Printed in U.S.A.

© Copyright by the Gorman-Rupp Company

## INTRODUCTION

**Thank You** for purchasing a Gorman-Rupp SM Series Pump. **Read this manual** carefully to learn how to safely maintain and service your pump. Failure to do so could result in personal injury or damage to the pump.

A set of three manuals accompanies your pump. The Installation/Operation Manual contains essential information on installing and operating the pump, and on making electrical connections. The Parts List Manual provides a performance curve, a pump model cross-section drawing, and parts list for your pump.

This Maintenance and Repair Manual provides troubleshooting and maintenance instructions required to properly diagnose operational problems, and to service the pump components. Pump motor maintenance may be performed **only** by a Gorman-Rupp authorized Submersible repair facility, or the factory. Otherwise, the pump warranty will be negated, and damage to the pump, and injury or death to personnel can result. Contact the factory for the authorized repair facility closest to you.

As described on the following page, this manual will alert personnel to known procedures which re-

quire special attention, to those which could damage equipment, and to those which could be dangerous to personnel. However, this manual cannot possibly anticipate and provide detailed precautions for every situation that might occur during maintenance of the unit. Therefore, it is the responsibility of the owner/maintenance personnel to ensure that **only** safe, established maintenance procedures are used, and that any procedures not addressed in this manual are performed **only** after establishing that neither personal safety nor pump integrity are compromised by such practices.

If there are any questions regarding the pump which are not covered in this manual or in other literature accompanying the unit, please contact your Gorman-Rupp distributor or the Gorman-Rupp Company:

**The Gorman-Rupp Company**  
**P.O. Box 1217**  
**Mansfield, Ohio 44901-1217**  
 or:  
**Gorman-Rupp of Canada Limited**  
**70 Burwell Road**  
**St. Thomas, Ontario N5P 3R7**

## CONTENTS

### SAFETY – SECTION A

### TROUBLESHOOTING – SECTION B

ELECTRICAL TESTING .....	PAGE B – 2
Test Equipment .....	PAGE B – 3
Voltage Imbalance .....	PAGE B – 3
Motor and Power Cable Continuity .....	PAGE B – 3
Insulation Resistance .....	PAGE B – 4

### PUMP MAINTENANCE AND REPAIR – SECTION C

GENERAL INFORMATION .....	PAGE C – 1
Lifting .....	PAGE C – 1
TYPICAL PUMP ASSEMBLY .....	PAGE C – 2
PUMP ASSEMBLY PARTS IDENTIFICATION LIST .....	PAGE C – 3
PUMP END DISASSEMBLY .....	PAGE C – 4
PUMP END REASSEMBLY .....	PAGE C – 6
MOTOR DISASSEMBLY .....	PAGE C – 9
MOTOR REASSEMBLY .....	PAGE C – 12
FINAL ASSEMBLY .....	PAGE C – 17
VACUUM TESTING .....	PAGE C – 17
LUBRICATION .....	PAGE C – 19

## RECORDING MODEL AND SERIAL NUMBERS

Please record the pump model, serial number, voltage, and motor frame size in the spaces provided below. Your Gorman-Rupp distributor needs this information when you require parts or service.

Pump Model: \_\_\_\_\_

Serial Number: \_\_\_\_\_

Voltage: \_\_\_\_\_

Phase: \_\_\_\_\_

## WARRANTY INFORMATION

The warranty provided with your pump is part of Gorman-Rupp's support program for customers

The following are used to alert personnel to procedures which require special attention, to those which could damage equipment, and to those which could be dangerous to personnel:



**Immediate hazards which WILL result in severe personal injury or death. These instructions describe the procedure required and the injury which will result from failure to follow the procedure.**

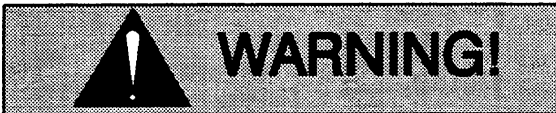

**Hazards or unsafe practices which COULD result in severe personal injury or death. These instructions describe the procedure required and the injury which could result from failure to follow the procedure.**

who operate and maintain their equipment as described in this and the other accompanying literature. The integral electric motor must be operated through the control furnished with the pump as standard equipment and approved by MSHA. Please note that should the equipment be abused or modified to change its performance beyond the original factory specifications, the warranty will become void and any claim will be denied.

All repairs to the pump motor **must** be performed by a Gorman-Rupp authorized Submersible repair facility or the factory. Any repairs to the motor assembly performed by the customer or an unauthorized repair facility negates motor warranty.



Hazards or unsafe practices which COULD result in minor personal injury or product or property damage. These instructions describe the requirements and the possible damage which could result from failure to follow the procedure.

### NOTE

*Instructions to aid in installation, operation, and maintenance or which clarify a procedure.*

## SAFETY – SECTION A

The following information applies throughout this manual to Gorman-Rupp SM Series submersible motor driven pumps.

This manual will alert personnel to known procedures which require special attention, to those which could damage equipment, and to those which could be dangerous to personnel. However, this manual cannot possibly anticipate and provide detailed instructions and precautions for every situation that might occur during maintenance of the unit. Therefore, it is the responsibility of the owner/maintenance personnel to ensure that only safe, established maintenance procedures are used, and that any procedures not addressed in this manual are performed only after establishing that neither personal safety nor pump integrity are compromised by such practices.

This manual contains essential information on troubleshooting and maintaining the pump. In addition to this manual, see the separate literature covering installation and operation, pump parts, and any optional equipment shipped with the pump.

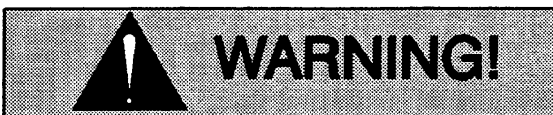

Before attempting to open or service the pump:

1. Familiarize yourself with this manual.
2. Lock out incoming power to the control box to ensure that the pump will remain inoperative.
3. Allow the pump to completely cool if overheated.

4. Close the discharge valve (if used).

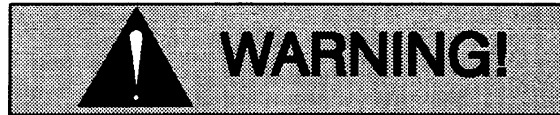

This pump is not designed to pump volatile, explosive, or flammable materials. Do not attempt to pump any liquids for which your pump is not approved, or which may damage the pump or endanger personnel as a result of pump failure. Consult the factory for specific application data.



Before connecting any cable to the control box, be sure to ground the control box. Refer to the Control Box manual for the suggested grounding methods.

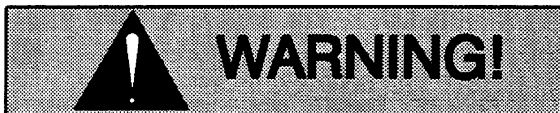

The pump is designed to be operated through the control box furnished with the pump. The control box provides overload protection and power control. Do not connect the pump motor directly to the incoming power lines.

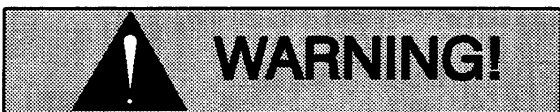

When installing or servicing the pump or controls, follow all requirements for the installation of wiring or electrical equipment as outlined by MSHA SCHEDULE 2G. Follow all MSHA safety requirements. Failure to observe these requirements could result in injury or death to personnel.



The electrical power used to operate this pump is high enough to cause injury or death. Obtain the services of a qualified electrician to make all electrical connections. Make certain that the pump and enclosure are properly grounded; never use gas pipe as an electrical ground. Be sure that the incoming power matches the voltage and phase of the pump and control before connecting the power source. Do not run the pump if the voltage is not within the limits. If the overload unit is tripped during pump operation, correct the problem before restarting the pump.

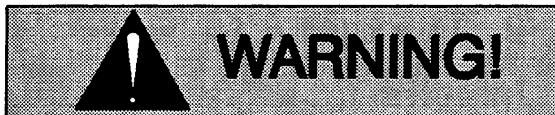

The electrical power used to operate this pump is high enough to cause injury or death. Make certain that the control handle on the control box is in the OFF position and locked out, or that the power supply to the control box has been otherwise cut off and locked out, before attempting to open or service the pump assembly. Tag electrical circuits to prevent accidental start-up.

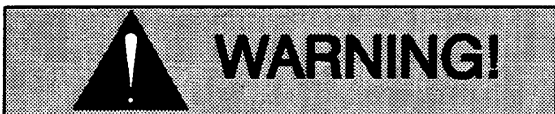

Any control box used to operate the pump must be approved by the MSHA and the Gorman-Rupp Company for the application.

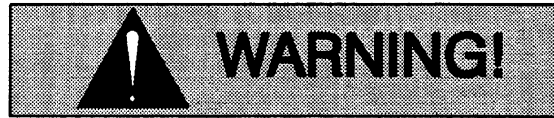

Never attempt to alter the length or repair any power cable with a splice. The pump motor and cable must be completely waterproof. Injury or death may result from alterations.

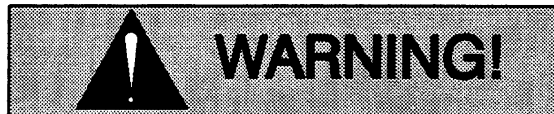

All electrical connections must be in accordance with MSHA Schedule 2G. If there is a conflict between the instructions provided and MSHA specifications, MSHA specifications shall take precedence. All electrical equipment supplied with this pump was in conformance with MSHA requirements in effect on the date of manufacture. Failure to follow applicable specifications, or substitution of electrical parts not supplied or approved by the manufacturer, can result in severe injury or death.

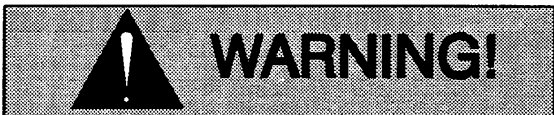

After the pump has been installed, make certain that the pump and all piping or hose connections are secure before operation.

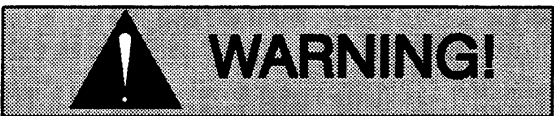

Approach the pump cautiously after it has been running. Although the motor is cooled by the liquid being pumped, normal operating temperatures can be high enough to cause burns. The temperature will be especially high if operated against a closed discharge valve. Never

operate against a closed discharge valve for long periods of time.

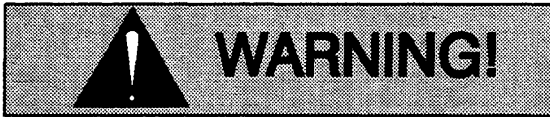

Do not attempt to lift the pump by the motor power cable or the piping. Attach proper lifting equipment to the lifting device fitted to the pump. If chains or cable are wrapped around the pump to

lift it, make certain that they are positioned so as not to damage the pump, and so that the load will be balanced.

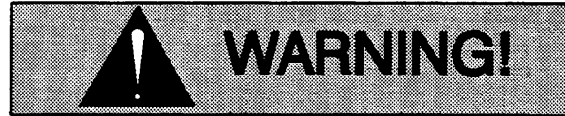

Obtain the services of a qualified electrician to troubleshoot, test and/or service the electrical components of this pump.



## TROUBLESHOOTING – SECTION B

Review all SAFETY information in Section A.



The following precautions should be taken before attempting to service the pump; otherwise, injury or death could result.

1. Familiarize yourself with this manual and with all other literature shipped with the pump.
2. Lock out incoming power to the pump or control box to ensure that the pump will remain inoperative.
3. Allow the pump to completely cool if overheated.
4. Check the temperature before opening any covers, plates or plugs.

5. Close the discharge valve (if used).

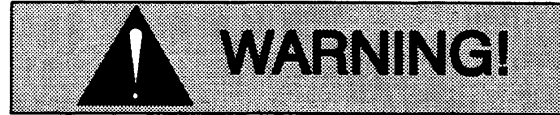

The electrical power used to operate this pump is high enough to cause injury or death. Obtain the services of a qualified electrician to troubleshoot, test and/or service the electrical components of this pump.

### NOTE

*Many of the probable remedies listed below require use of electrical test instruments; for specific procedures, see **ELECTRICAL TESTING** following the chart.*

**Table B-1 Troubleshooting Chart**

TROUBLE	CAUSE	REMEDY
<b>PUMP FAILS TO START, CIRCUIT BREAKER NOT TRIPPED</b>	Power source incompatible with control box.	Correct power source.
	No voltage at line side of circuit breaker.	Check power source for blown fuse, open overload unit, broken lead, or loose connection.
	Open circuit in motor windings or power cable.	Check continuity.
	Defective motor power cable.	Check for and replace defective unit.
<b>CIRCUIT BREAKER TRIPS</b>	Low or high voltage, or excessive voltage drop between pump and control box.	Measure voltage at control box. Check that wiring is correct type, size, and length. (See <b>Field Wiring Connections</b> , Operations And Maintenance Manual.
	Defective insulation in motor windings.	Check insulation resistance; check continuity.
	Impeller jammed due to debris or insufficient clearance.	Disassemble pump and check impeller.
	Bearing(s) frozen.	Disassemble pump and check bearing(s).



Table B-1 Troubleshooting Chart (continued)

TROUBLE	CAUSE	REMEDY
<b>MOTOR RUNS, BUT PUMP FAILS TO DELIVER RATED DISCHARGE</b>	Discharge head too high.	Reduce discharge head, or install staging adaptor and additional pump.
	Low or incorrect voltage.	Measure control box voltage, both when pump is running and when shut off.
	Discharge throttling valve partially closed; check that valve is installed improperly.	Open discharge valve fully; check piping installation.
	Discharge line clogged or restricted; hose kinked.	Check discharge lines; straighten hose.
	Liquid being pumped too thick.	Dilute liquid if possible.
	Strainer screen or impeller clogged.	Clear clog(s). Stop pump; back flow may flush away debris.
	Insufficient liquid in sump or tank.	Stop pump until liquid level rises.
	Worn impeller vanes; excessive impeller clearance.	Check impeller and clearance. See <b>PUMP END REASSEMBLY</b> .
Pump running backwards.	Check direction of rotation and correct by interchanging any two motor leads at control box. (See <b>Pump Rotation</b> , Section C).	
<b>PUMP RUNS WITH EXCESSIVE NOISE OR VIBRATION</b>	Pumping entrained air.	Check liquid level in sump; check position of pump and liquid level sensing device(s).
	Damaged or unbalanced impeller.	Replace impeller.
	Discharge piping not properly supported.	Check piping installation.
	Impeller jammed or loose.	Check impeller.
	Pump cavitation.	Reduce discharge head, or restrict flow on low head applications.
	Motor shaft or bearings defective.	Disassemble pump and check motor and bearings.

**ELECTRICAL TESTING**

If you suspect that pump malfunctions are caused by defects in the motor, power cable or control box, perform the following checks to help isolate the defective part.



**Obtain the services of a qualified electrician to troubleshoot, test and/or service the electrical components of this pump.**



Be certain to refer to the wiring diagram(s) before reconnecting any electrical components which have been disconnected.

### Test Equipment

A volt/amp/ohmmeter and megohmmeter of adequate range and quality will be required to conduct the following electrical tests. The suggested equipment indicated below is commercially available, or an equivalent substitute may be used.

Equipment	Use
Ammeter	To check AC Voltage and current (amperage)
Ohmmeter	To measure resistance (ohms) to ground

### Voltage Imbalance

Each phase of the incoming three-phase power must be balanced with the other two as accurately as a commercial voltmeter will read. If the phases are balanced, check out the motor as described below. If the phases are out of balance, contact your power company and request that they correct the condition.

- Use a voltmeter, amprobe, or equivalent meter to read the voltage across terminals 1 & 2, 2 & 3, and 1 & 3 in the control box. All three measured voltages must be the same, as accurately as the meter will read. If possible, measure the voltage with the pump off, with the pump running but out of the water, and with the pump running in the water at full load. All the measured voltages at each condition must be the same.
- Use an amprobe or equivalent meter to measure the current draw of each phase while the pump is running at full load and at no load. All three amperage readings must

be the same at each condition, as accurately as the meter will read. Nominal amperage values are listed in Table 1, but these apply only when the actual voltage at the site is the nominal voltage listed.

- If the voltages are balanced with the pump off, but are unbalanced when the pump is running, a thorough check of the power source, all interconnecting cables, and the pump motor is required to isolate the defect.

### Motor And Motor Power Cable Continuity

To check continuity, zero-balance the ohmmeter set at the RX1 scale, and test as follows:

- Disconnect the motor power cable leads from the control box and connect the test leads to any two of the three power cable leads (not to the green ground lead or yellow ground check lead). If there is a high resistance reading on the ohmmeter, there is an open or broken circuit cause a break in the power cable or motor windings, or by a bad connection between the motor and the power cable. Switch one test lead to the third power lead, and test again.
- If an open or broken circuit is indicated, check the power cable for obvious damage, and replace as necessary (see **MAINTENANCE AND REPAIR**). If there is no apparent damage to the motor cable, remove the terminal housing (see **MAINTENANCE AND REPAIR**) and check the continuity of each power cable lead at the terminal posts.
- If an open circuit still exists after each lead (terminal) has been tested and tightened, then the **entire** motor power cable must be replaced. Splicing or other means of repair are not recommended.
- If no break is found in the power cable, check the motor leads for continuity. If the test reading indicates an open or broken circuit, there is an open circuit in the motor.

### NOTE

*It is recommended that a pump with a defective motor be returned to Gorman-Rupp, or to one of the Gorman-Rupp authorized Submersible Repair centers.*

**Insulation Resistance**

To check insulation, zero-balance the ohmmeter set at the RX100K scale, and test as follows:

- a. Disconnect the motor power cable leads from the control box. Connect one test lead to the power cable green ground lead, and touch the other test lead to each of the three power leads in turn.
- b. The reading obtained will indicate resistance values in both the power cable and the motor windings. If the resistance reading is infinity ( $\infty$ ), the insulation is in good condi-

tion. If the reading is between infinity ( $\infty$ ) and 1 megohm, the insulation is acceptable but should be rechecked periodically. If the reading is less than 1 megohm, the insulation should be checked more closely; a reading of zero indicates that the power cable or the motor is grounded.

- c. To determine whether the power cable or the motor is grounded, remove the terminal housing (see **MAINTENANCE AND REPAIR**), disconnect the motor leads from the motor terminals, and test the power cable leads and motor leads separately.

## PUMP MAINTENANCE AND REPAIR – SECTION C

### GENERAL INFORMATION

Review all SAFETY information in Section A.

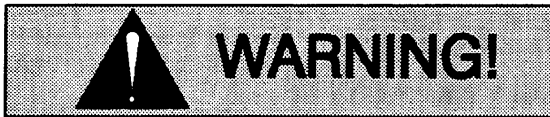

**Do not attempt to service the pump assembly unless all power to the motor has been shut off at the control box; otherwise, injury or death could result.**

**Use a lifting device with sufficient capacity. If slings or chains are used to move the pump or components, make sure that the load is balanced; otherwise serious personal injury or death could result.**

The maintenance and repair instructions in this manual are keyed to the sectional views, Figures C-1 and C-2, and the corresponding parts identification lists. Refer to the separate Parts List Manual for replacement parts.

Select a suitable location, preferably indoors, to perform required maintenance. All work must be performed by qualified personnel.



All repairs to the pump motor must be per-

formed by a Gorman-Rupp authorized Submersible repair facility or the factory. Any repairs to the motor assembly performed by the customer or an unauthorized repair facility negates the warranty.

This Maintenance and Repair Manual provides troubleshooting and maintenance instructions required to properly diagnose operational problems, and to service the pump components. Pump motor maintenance may be performed **only** by a Gorman-Rupp authorized Submersible repair facility, or the factory. Otherwise, the pump warranty will be negated, and damage to the pump, and injury or death to personnel can result. Contact the factory for the authorized repair facility closest to you.

Check **TROUBLESHOOTING**, Section B to determine causes and remedies of pump problems. Disassemble the pump only as far as required.

#### Lifting

Use lifting equipment with a capacity of **at least five times the weight of the pump**, including the weight of any options or customer-installed accessories. The approximate maximum weight for this group of pumps is **253 lbs. (115 kg.)**, not including the cable. Discharge hose or piping **must** be removed before attempting to lift the pump.



### Typical SM4K Series Pump Assembly Parts Identification List

Refer to the separate Parts List Manual for serviceable parts, part numbers and quantities.

ITEM NO.	PART NAME	ITEM NO.	PART NAME
1	IMPELLER	40	DRIVE SCREW
2	DIFFUSER	41	ALLEN HEAD SETSCREW
3	LOWER SEAL ASSEMBLY	42	LEAD SEAL
4	UPPER SEAL ASSEMBLY	43	SEALING WIRE
5	RETAINING RING	44	ALLEN HEAD SETSCREW
6	DIFFUSER O-RING	45	TERMINAL HOUSING
7	INTERMEDIATE	46	T-TYPE LOCKWASHER
8	SEAL CAVITY PIPE PLUG	47	ROUND HEAD MACHINE SCREW
9	FLAT HEAD MACHINE SCREW	48	TERMINAL HOUSING O-RING
10	SEAL PLATE O-RING	49	WIRE CONNECTOR
11	LOWER MOTOR HOUSING	50	STUD
12	INTERMEDIATE O-RING	51	LOCKWASHER
13	LWR MOTOR HOUSING O-RING	52	HEX NUT
14	LOWER BALL BEARING	53	STATOR ASSEMBLY
15	LOWER BEARING SNAP RING	54	ROTOR & SHAFT ASSEMBLY
16	LWR BEARING RETAINING RING	55	STUD
17	MIDDLE MOTOR HOUSING	56	LOCKWASHER
18	PUMP CASING	57	HEX NUT
19	UPPER MTR HOUSING O-RING	58	INTERMEDIATE O-RING
20	PIPE PLUG	59	PUMP CASING O-RING
21	ALLEN HEAD SETSCREW	60	SOCKET HEAD CAPSCREW
22	UPPER MOTOR HSG	61	SEAL PLATE
23	UPPER BALL BEARING	62	HEX HEAD CAPSCREW
24	PUMP CASING O-RING	63	LOCKWASHER
25	BUSHING	64	STRAINER ASSEMBLY
26	HEX HEAD CAPSCREW	65	IMPELLER FLAT WASHER
27	LOCKWASHER	66	IMPELLER NUT
28	FLAT WASHER	67	IMPELLER KEY
29	HOIST BAIL ASSEMBLY	68	IMP ADJUSTING SHIM SET
30	STUD	69	STRAINER SUPPORT
31	HEX NUT	70	HEX HEAD CAPSCREW
32	DISCHARGE FLANGE	71	LOCKWASHER
33	DISCHARGE FLANGE GASKET	72	SEAL SLEEVE
34	HEX HEAD CAPSCREW	73	SPRING HOLDER
35	LOCKWASHER	74	DRIVE SCREW
36	CABLE ASSEMBLY	75	MSHA APPROVAL PLATE
37	HOSE CLAMP	76	DRIVE SCREW
38	CABLE GRIP ASSEMBLY	77	NAME PLATE
39	CERTIFICATION PLATE		

## PUMP END DISASSEMBLY

Review all SAFETY information in Section A.

Follow the instructions on all tags, label and decals attached to the pump.

All functions performed by the customer on the pump or control must be done in accordance with MSHA, schedule 2G regulations to ensure the explosion-proof integrity. No alterations of original design may be made without the consent of the Gorman-Rupp Company and MSHA.

The following maintenance and repair instructions are keyed to the Pump Model sectional view (C-1) and the accompanying parts list.

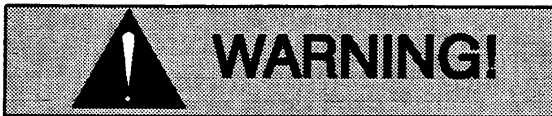

The pump motor is thermally protected and subject to automatic restart. Always terminate power to the pump and control box before performing service functions.

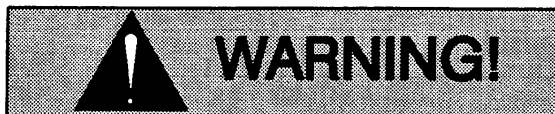

The electrical power used to operate this pump is high enough to cause injury or death. Make certain that the control handle on the control box is in the **OFF** position and locked out, or that the power supply to the control box has been otherwise cut off and locked out, before attempting to open or service the pump assembly. Tag electrical circuits to prevent accidental start-up.

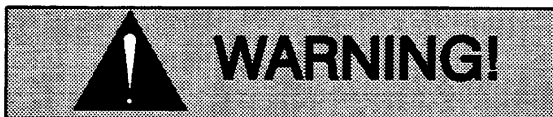

Do not open the control box in an explosive atmosphere. When sealed, the control box is explosion proof to prevent the ignition of combustible gases. Opening the box in an explosive atmosphere could result in fire or explosion.

Before attempting to service the pump or control, terminate the power supply to the control box. Close the discharge throttling valve, if so equipped.

Use the hoisting bail to remove the pump from the wet well or sump, and move it to a location where the discharge line can be removed. It is not necessary to disconnect a flexible discharge hose before removing the pump. If rigid discharge piping is used, disconnect the piping before attempting to move the pump.

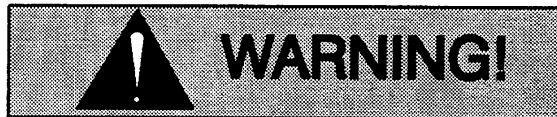

Do not attempt to lift the pump by the motor power cable or the piping. Attach proper lifting equipment to the lifting device fitted to the pump. If chains or cable are wrapped around the pump to lift it, make certain that they are positioned so as not to damage pump, and so that the load will be balanced.

Select a suitable location, preferably indoors, to perform the degree of maintenance required. If the motor housing is to be opened, the work must be done in a clean, well-equipped shop. All maintenance functions must be done by qualified personnel.

Check the chart in TROUBLESHOOTING, Section D, to determine the nature of the pump problem. If the problem is mechanical in nature, such as worn pump parts, seal replacement, lubrication, etc., refer to PUMP END DISASSEMBLY for instructions.

If the problem is electrical, complete disassembly may not be required. Refer to Electrical Testing in TROUBLESHOOTING, Section D, and have a qualified electrician check the control box, cable and terminal housing. If the problem is determined to be in the motor, proceed with PUMP END DISASSEMBLY, followed by MOTOR DISASSEMBLY. Otherwise, see Terminal Housing And Power Cable Disassembly.

Carefully inspect any O-rings or gaskets before removal and cleaning to determine if a proper seal and compression existed prior to disassembly. If sealing was faulty or questionable, the cause must be determined and corrected before reassembly.

All gaskets and most O-rings **must** be replaced if disturbed. Repair gaskets and O-rings are listed on the parts list.

## PUMP END DISASSEMBLY

### Strainer Removal

(Figure C-1)

To remove the strainer (64), raise the pump slightly, or lay it on its side and disengage the strainer hardware (70 and 71). Remove the strainer and supports (69). If the impeller is clogged, the debris can usually be removed without further disassembly.

### Draining Oil From Seal Cavity

(Figure C-1)

If any further disassembly is to be performed on the pump, the seal oil cavity must be drained.



Let the pump cool before removing the seal cavity drain plug. Pressure built up within a hot pump could cause the oil to spray out when the plug is removed. Remove the plug slowly and permit pressure to vent to atmosphere.

Lay the pump on its side with the seal cavity drain plug (8) facing up. Clean any dirt from around the plug before removing it. Remove the plug, and install a short 1/4-inch NPT nipple in the hole. Tip the pump and drain the seal oil into a **clean** container. Inspect the oil for water, dirt, or cloudy condition which could indicate lower seal failure or poor gasket seal.

### Positioning Pump For Disassembly

(Figure C-1)

It is recommended that the pump be positioned upside-down during disassembly. To hold the pump in the inverted position, screw a pipe in the discharge flange (32) and clamp it in a large vise, or remove the discharge flange and secure the flange studs (30) to a bench or work stand. The pump

may also be rested securely on blocks. Be careful not to damage the terminal housing or cable while in this position. Use adequate equipment and personnel to safely handle the pump until it is secured. If inverting the pump is not practical, lay the pump on its side and secure it to prevent rolling.

### Diffuser Removal

(Figure C-1)

Remove the hardware (62 and 63) securing the diffuser (2) to the seal plate (61) and intermediate (7). Remove the diffuser, and remove and discard the diffuser O-ring (6).

### Impeller Removal

(Figure C-1)

Temporarily reinstall two of the capscrews (62). Wedge a piece of wood between the vanes of the impeller (1) and the capscrews to prevent shaft rotation. Remove the impeller locknut (66) and washer (65).

Remove the wood from the impeller vanes, and remove the capscrews (62) temporarily installed in the seal plate and intermediate. Install the impeller puller supplied with the pump, and pull the impeller from the shaft. Use caution when removing the impeller; tension on the seal spring will be released. Retain the impeller key (67).

Remove the impeller adjusting shims (68); tie and tag the shims, or measure and record their thickness for ease of reassembly.

### Lower Seal Removal

(Figures C-1 and C-2)

Remove the seal spring retainer and seal spring. Carefully slide the seal sleeve (72) and rotating portion of the seal (3) off the shaft. Lubricate the seal sleeve, and work oil up under the rubber bellows. Carefully slide the rotating portion of the lower seal assembly off the seal sleeve.

To remove the stationary portion of the seal, remove the flat head machine screws (9), and slide the seal plate off the shaft. Remove and discard the seal plate O-ring (10).

Place the seal plate on a flat surface with the impeller side down. Press the stationary cup and seat out of the seal plate from the backside.



An alternate method of removing the stationary portion of the seal without removing the seal plate is to slide a pair of stiff wires with hooked ends along the shaft and hook the stationary seat from the back side. Use the wires to pull the stationary portion of the seal from the seal plate.

The rotating and stationary seal elements are precision finished and subject to wear. The complete seal should be replaced with each overhaul to ensure trouble-free operation. However, if the old seal must be reused, wrap the seal faces individually in clean tissue paper to prevent damage to the sealing surfaces.

If no further disassembly is required, proceed to the appropriate areas in **PUMP END REASSEMBLY**.

### Upper Seal Removal

(Figures C-1 and C-2)

Unless cracked or otherwise worn, it is not necessary to remove the intermediate (7) for access to the upper seal assembly (4).

If intermediate removal is desired, disengage the socket head capscrews (60) and separate the intermediate from the lower motor housing (11). Remove the intermediate, and remove and discard the O-rings (12, 58 and 59). Remove the pump casing (18) and discard the O-ring (24).

Remove the seal retaining ring (5) with snap ring pliers. Use caution when removing the retaining ring; tension on the seal spring will be released. Remove the seal spring holder (73) and spring. Lubricate the shaft adjacent to the seal, and work oil up under the rubber bellows. Position a screwdriver or other suitable device on each side of the bellows retaining flange, and pry upward until the rotating portion is off the shaft.

Slide the hook ends of two stiff wires along the shaft and under the stationary seal seat. Hook the back side of the seat, and pull the seat and stationary element from the lower motor housing (11).

With the pump inverted, stuff a clean tissue into the seal bore of the lower motor housing (or wrap a small rag around the shaft) to prevent foreign material from entering the motor cavity.

### NOTE

*Do not disassemble the motor unless it is necessary, and a clean, well-equipped shop is available. If the motor housing components are to be serviced, see **MOTOR DISASSEMBLY** in this section. Do not reassemble the pump end components at this time.*

If no further disassembly is required, proceed to **PUMP END REASSEMBLY**.

### PUMP END REASSEMBLY

### NOTE

*Reuse of old O-rings, gaskets, or shaft seal parts may result in premature leakage or reduced pump performance. It is strongly recommended that new gaskets and shaft seal assemblies be used during reassembly (see the parts list for numbers).*

### Cleaning And Inspection Of Pump Parts

(Figure C-1)

Carefully inspect any O-rings or gaskets before removal and cleaning to determine if a proper seal and compression existed prior to disassembly. If sealing was faulty or questionable, the cause must be determined and corrected before reassembly. Replace any parts as required.

Thoroughly clean all reuseable parts with a soft cloth soaked in cleaning solvent. Use a clean cloth lightly dampened with solvent to clean the lower motor housing, intermediate, and seal plate. Do not allow the solvent to enter the motor.

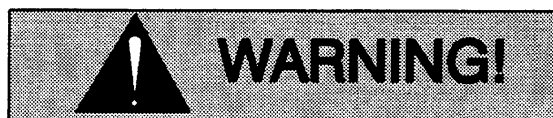

**Most cleaning solvents are toxic and flammable. Use them only in a well ventilated area free from excessive heat, sparks, and flame. Read and follow all precautions printed on solvent containers.**

Remove all O-rings and gaskets, and clean the sealing surfaces of dirt or gasket material. Be careful not to scratch gasket surfaces.

Inspect the rotor shaft for damaged threads, scoring, or nicks. Remove nicks and burrs with a fine file or emery cloth to restore original contours. If the shaft is bent or severely damaged, the rotor and shaft must be replaced as an assembly (see **MOTOR DISASSEMBLY**).

Neither of the shaft seal assemblies should be reused because wear patterns on the finished faces cannot be realigned during reassembly. This could result in premature failure. If necessary to reuse an old seal in an emergency, **carefully** wash all metallic parts in fresh cleaning solvent and allow to dry thoroughly.

Handle the seal parts with extreme care to prevent damage. Be careful not to contaminate the precision finished faces; even fingerprints on the faces can shorten seal life. If necessary, clean the faces with a non-oil based solvent and a clean, lint-free tissue. Wipe **lightly** in a concentric pattern to avoid scratching the faces.

Inspect the seal components for wear, scoring, grooves, and other damage that might cause leakage. If any components are worn, replace the complete seal; **never mix old and new seal parts**.

Install the shaft seals as illustrated in Figure C-2.

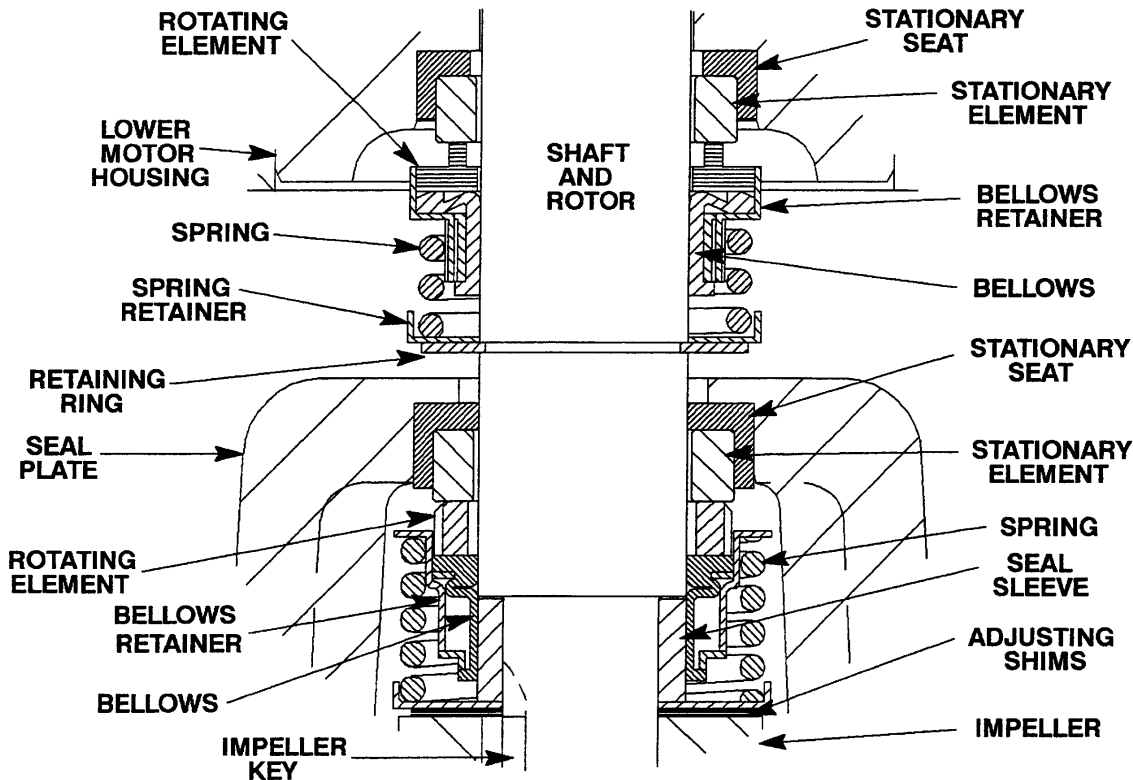

Figure C-2. Lower And Upper Seal Assemblies



This seal is not designed for operation at temperatures above 160° F. Do not use at higher operating temperatures.

#### Upper Seal Installation

(Figures C-1 and C-2)

If a **new** upper seal assembly is to be installed, do not unwrap it until time of installation. Cleanliness of seal components is critical, especially the seal faces.

Carefully remove the material stuffed into the lower motor housing seal seat bore (or unwrap the shaft). **Be sure** no debris stopped by the material falls into the motor cavity.

Clean the rotor shaft and seal cavity area of the lower motor housing (11). Be sure the area is dry and free of lint and dirt. **Do not** permit cleaning solvent or debris to fall into the motor cavity. Check the seal bore for burrs or nicks that might prevent a good seal. Apply a **light** coating of oil to the bore.

Unpack the stationary seat and element. Apply a **light** coating of oil to the stationary seat. Keep the sealing face dry.

#### NOTE

*When pressing seal components onto the rotor shaft, use hand pressure only. A push tube cut from a length of plastic pipe will aid in installing seal components. The I.D. of the push tube should be approximately the same as the I.D. of the seal spring.*

Position the seat in the bore with the sealing face up, and cover it with a clean tissue. Use your thumbs to press the seal into the bore. Apply equal pressure on opposite sides of the sealing element until it is fully seated in the bore. Remove the tissue and inspect the seal face to ensure that it is clean and dry. If cleaning is necessary, use a clean tissue to wipe **lightly** in a circular pattern.

Unpack the rotating portion of the seal. Be certain the seal face of the rotating element is free of grit or surface damage. Place a **small** amount of grease at equal spaces on the back of the element, and assemble the drive grooves of the rotating element into the drive lugs of the bellows retainer. The grease should hold the element in position until the seal is installed.

Apply a light coating of oil to the seal seating surface on the shaft, the groove for the retaining ring (5), and the I.D. of the bellows. Apply a single drop of **light** lubricating oil to the precision-finished seal face. Position the rotating seal portion on the shaft with the seal face down. Apply firm, steady pressure on the bellows retainer until it slides down the shaft and the seal faces contact. This step should be done in one continuous motion to prevent the

bellows from sticking or rolling as it passes over the retaining ring groove.

Slide the seal spring over the shaft and against bellows retainer, and install the spring retainer (72). Install the seal retaining ring (5). See Figure C-2 for proper order of seal assembly.

#### Lower Seal Installation

#### (Figures C-1 and C-2)

Thoroughly clean the sealing surfaces and seal bore of the the seal plate (61). The seal bore must be free of burrs and nicks which could damage the seal.

#### NOTE

*When pressing seal components onto the impeller shaft, use hand pressure only. A push tube cut from a length of plastic pipe will aid in installing seal components. The I.D. of the push tube should be approximately the same as the I.D. of the seal spring.*

Apply a light coating of oil to the O-ring (24), and install it on the upper motor housing. Slide the pump casing (18) over the assembled motor until it seats against the O-ring and upper motor housing shoulder.

If the intermediate (7) was removed, lubricate the O-rings (12, 58 and 59) with light oil, and install them on the intermediate and lower motor housing (11). Apply 'Never-Seez' or equivalent compound on the threads of the socket head capscrews (60), and secure the intermediate to the lower motor housing by torquing the capscrews evenly in a cross sequence to 22 ft. lbs. (264 in. lbs. or 3.04 m. kg.).

Unpack the stationary seat and element. Apply a **light** coating of oil to the stationary seat. Keep the sealing face dry.

Position the seal plate (61) on a flat surface with the impeller side up. Position the seal stationary seat in the bore with the sealing face up, and cover it with a clean tissue. Use your thumbs to press the seal into the bore. Apply equal pressure on opposite sides of the sealing element until it is fully seated in the bore. Remove the tissue and inspect the seal face to ensure that it is clean and dry. If cleaning is

necessary, use a clean tissue to wipe **lightly** in a circular pattern.

Lubricate the O-ring (10) with light oil, and install it on the seal plate shoulder. Carefully position the seal plate and assembled stationary portion of the seal over the shaft and against the intermediate. **Be careful** not to damage the stationary element. Secure the seal plate to the intermediate with the flat head machine screws (9).

Unpack the rotating portion of the seal. Be certain the seal face of the rotating element is free of grit or surface damage. Place a **small** amount of grease at equal spaces on the back of the element, and assemble the drive grooves of the rotating element into the drive lugs of the bellows retainer. The grease should hold the element in position until the seal is installed.

Clean and polish the seal sleeve (72), or replace it if there are nicks or cuts on either end. Apply a light coating of oil to the sleeve and rotor shaft, and slide the sleeve onto the shaft until the chamfered end seats squarely against the shaft shoulder.

Apply a light coating of oil to the seating surface on the shaft and I.D. of the bellows. Position the rotating seal portion on the sleeve (25) with the seal face toward the chamfered end of the sleeve. Apply firm, steady pressure, with clean hands, on the seal retainer until it slides down the sleeve.

Slide the sleeve and rotating portion of the seal over the shaft until the sleeve seats squarely against the shaft shoulder. Continue to press on the seal retainer until the seal slides over the shaft and the seal faces contact.

Slide the seal spring over the shaft and bellows retainer. Install the spring retainer. See Figure C-2 for proper order of seal assembly.

### Impeller Installation

#### (Figure C-1)

Inspect the impeller for cracks, broken vanes, or wear from erosion, and replace it if damaged. Inspect the diffuser (2) and replace it if defective.

Install the same thickness of impeller adjusting shims (68) as previously removed onto the rotor shaft. Install the impeller key (67) in the rotor shaft

keyway, align the impeller keyway, and press the impeller onto the shaft until it seats firmly against the adjusting shims.

For maximum pump efficiency, there should be a clearance of .008 to .015 inch (0,2 to 0,4 mm) between the diffuser and the face of the impeller. The impeller must be fully seated in the shaft to determine this clearance. Install the impeller washer (65) and nut (66). Temporarily install two capscrews (62) in the seal plate and diffuser. Wedge a block of wood between the impeller vanes and capscrews to prevent shaft rotation, and torque the impeller locknut to 120 ft. lbs. (1440 in. lbs or 16,6 m. kg.).

Remove the temporarily installed capscrews (62), and position the diffuser against the seal plate. Reach through the diffuser opening with a feeler gauge and measure the impeller face clearance.

Adjust the clearance by adding or removing adjusting shims (68) as required.

When the impeller is properly positioned, coat the threads of the rotor shaft with 'Loctite Threadlocker No. 242' or equivalent compound, and install and re-torque the impeller nut.

### NOTE

*After the impeller has been properly positioned, check for free rotation. Correct any scraping or binding before further reassembly.*

Install the O-ring (6) on the diffuser. Position the diffuser (2) against the seal plate and intermediate, and secure it with the hardware (62 and 63).

### Strainer Installation

#### (Figure C-1)

Inspect the strainer screen for cracks or broken welds. Straighten or weld as required.

Install the strainer supports (69) and strainer (64), and secure it with the hardware (70 and 71). Tighten the capscrews just enough to draw the strainer screen down tightly, but not tight enough to distort it.

See **LUBRICATION** and **FINAL ASSEMBLY** before putting the pump back into service.

### MOTOR DISASSEMBLY

Disassembly of the motor is rarely required except to replace the motor rotor, stator or bearings. Do

not disassemble the motor unless it is necessary and a clean, well-equipped shop is available.

#### NOTE

*It is recommended that a pump with a defective motor be returned to Gorman-Rupp, or to one of the Gorman-Rupp authorized Submersible Repair Centers.*



Motor repairs **must be** performed in accordance with MSHA Specifications regarding the permissibility of this equipment. Refer to the **INSTALLATION AND OPERATIONS** manual.

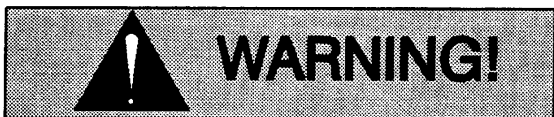

The electrical power used to operate this pump is high enough to cause injury or death. Make certain that the control handle on the control box is in the **OFF** position and locked out, or that the power supply to the control box has been otherwise cut off and locked out, before attempting to open or service the pump assembly. Tag electrical circuits to prevent accidental start-up.

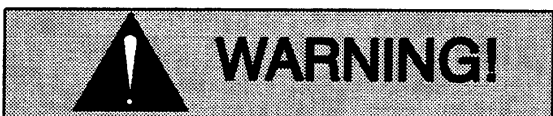

**Do not remove the control box cover in an explosive atmosphere. When sealed, the control box is explosion proof to prevent the ignition of combustible gases. Opening the box in an explosive atmosphere could cause fire or explosion.**

Carefully inspect any O-rings or gaskets before removal and cleaning to determine if a proper seal and compression existed prior to disassembly. If sealing was faulty or questionable, the cause must be determined and corrected before reassembly. Replace any parts as required.

#### Terminal Housing And Power Cable Removal (Figure C-1)

Total disassembly of the terminal housing and power cable is not always required. Disassemble and replace **only** the parts proven defective by inspection or testing. See **Electrical Testing** in **TROUBLESHOOTING**.

The terminal housing and power cable may be serviced without disassembling the motor housing or pump end.

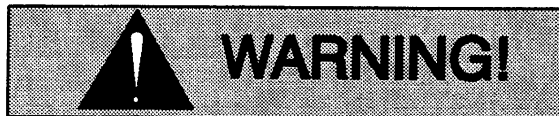

**Do not remove the terminal housing in an explosive atmosphere. The terminal housing and its O-ring must remain intact to retain the permissibility of this equipment. Removing the housing in an explosive atmosphere could cause fire or explosion.**

Secure the pump in an upright position. To remove the terminal housing, disengage the hardware (34 and 35) securing the terminal housing (45) to the upper motor housing (22).

Carefully raise the terminal housing from the motor housing until the wire connectors (49) are accessible. Remove the underwater tape and unscrew the wire connectors. Disconnect the motor leads from the power cable leads. Separate the terminal housing and power cable assembly from the motor housing.

Remove the O-ring (48) from the terminal housing. No further disassembly is required to test the stator or power cable.

#### Power Cable Removal (Figure C-1)

To remove the power cable and cable grip (38), disengage the hardware (46 and 47), and disconnect the green ground lead and the yellow ground check lead from the terminal housing.

Remove the setscrew (44) which locks the cable grip body in place in the terminal housing. Cut and remove the seal wire (43) which retains the cable

grip to the terminal housing. Unscrew the cable and grip as an assembly from the terminal housing. Cut the silicone adhesive from around the power cable leads in the bottom of the grip body.

To remove the cable grip assembly from the power cable, remove the hose clamp (37), and unscrew the grip nut from the cable grip body. Pull the cable, cable grip mesh, and rubber grommet from the grip body.

Apply oil to the cable O.D., and work it up under the grommet. Slide the grommet off the cable. Compress the wire mesh of the cable grip, and slide the mesh and grip nut off the cable.

See **Terminal Housing And Power Cable Reassembly** if no further disassembly is required.

### Shaft And Rotor Removal

(Figure C-1)

See **PUMP END DISASSEMBLY**, and remove all pump end and seal components (including the lower motor housing, rotor and shaft assembly).

With the pump end disassembled and the terminal housing removed, secure the pump in an inverted position.

If the intermediate (7) was not removed during pump end disassembly, disengage the socket head capscrews (60) and remove the intermediate at this time. Remove the O-rings (12, 58 and 59) and the pump casing (18) and O-ring (24).

Remove the hardware (56 and 57). Slide the assembled lower motor housing (11), shaft and rotor (54), and bearings (14 and 23) out of the stator (53) and upper motor housing (22).

Remove the retaining ring (16), and slide the lower motor housing off the lower bearing.

### NOTE

*If necessary, tap around the edge of the lower motor housing with a soft-faced mallet or a block of wood to separate the motor housing from the bearing.*

Before removing the bearings from the rotor shaft, clean and inspect the bearings **in place** as follows.



To prevent damage during removal from the shaft, it is recommended that bearings be cleaned and inspected **in place**. It is **strongly** recommended that the bearings be replaced **any** time the shaft and rotor assembly is removed.

Clean the bearings thoroughly in **fresh** cleaning solvent. Dry the bearings with filtered compressed air and coat with light oil.

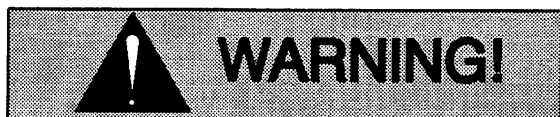

**Most cleaning solvents are toxic and flammable. Use them only in a well ventilated area free from excessive heat, sparks, and flame. Read and follow all precautions printed on solvent containers.**

Rotate the bearings by hand to check for roughness or binding. If rotation is rough, replace the bearings.

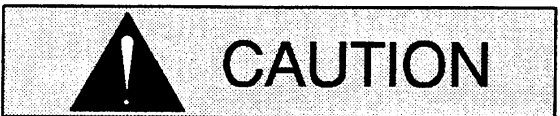

These bearings are permanently sealed and require no additional lubrication except a coating of light oil on external surfaces to ease reassembly. External surfaces must be kept free of all dirt and foreign material. Failure to do so could damage the bearings or their mating surfaces.

The bearing tolerances provide a tight press fit onto the shaft and a snug slip fit into the upper and lower motor housings. Replace the shaft and rotor (as an assembly), or the upper and lower motor housings if the proper bearing fit is not achieved.

If the bearings require replacement, use a suitable puller to remove them from the shaft.

It is not necessary to remove the retaining ring (15) from the shaft unless replacement is required. Use snap ring pliers to remove the retaining ring.

If no further disassembly is required, cover the middle and upper motor housings with a clean, lint-free cloth to avoid contamination of the stator by dirt or other foreign material.

### Stator Removal

(Figure C-1)

Do not remove the stator (53) unless it is defective (open windings, insulation resistance low, or stator core damaged). If the stator must be removed, remove the terminal housing as indicated in **Terminal Housing And Power Cable Disassembly**.

Remove the pipe plugs (20) and loosen the allen head setscrews (21).

Position an expandable tool, such as a split disc, approximately 2 inches (51 mm) down inside the stator, and expand it tightly and squarely on the I.D. Attach a lifting device to the lifting eye of the tool, and raise the assembly approximately 1 inch (25 mm) off the work surface. Take care not to damage the stator end turns. Use a soft-faced mallet to rap alternate edges of the upper motor housing and "walk" the stator out. Continue this process until the stator clears the motor housing.

### NOTE

*It may be necessary to heat the motor housings to permit stator removal. Apply heat evenly to the outside of the housings; excessive heat is not required.*

After the stator has been removed, wrap it in clean, dry rags or other suitable material. The stator **must** be kept clean and dry. When handling the stator, **do not** set it on the end windings; lay it on its side.



Do not attempt to rewind the stator. winding tolerances and materials are closely controlled by the manufacturer, and any deviation can cause damage or operating problems. Replace the stator, or return it to one of the Gorman-Rupp Authorized Submersible Repair Centers or the Gorman-Rupp Factory, if defective.

It is not necessary to separate the upper and middle motor housings (17 and 22) unless replacement of the O-ring (19) or one of the motor housings is required. Remove the hardware (51 and 52) to separate the motor housings, and remove and discard the O-ring.

### Hoisting Bail

(Figure C-1)

If the hoisting bail (29) requires replacement, remove the hardware (26, 27 and 28) securing the bail to the upper motor housing. Remove the bushings (25).

## MOTOR REASSEMBLY

### NOTE

*Reuse of old O-rings, gaskets, shaft seal parts may result in premature leakage or reduce pump performance. It is strongly recommended that new gaskets and shaft seal assemblies be used during reassembly (see the parts lists for numbers).*

### Stator Installation

(Figure C-1)



Do not attempt to rewind the stator. Winding tolerances and materials are closely controlled by the manufacturer, and any deviation can cause damage or operating problems. Replace the stator, or return it to one of the Gorman-Rupp Authorized Submersible Repair Centers or the Gorman-Rupp factory, if defective.

Clean all gasket and O-ring surfaces, completely removing any old gasket and cement material. Inspect the sealing surfaces for burrs, nicks and pits which could cause a poor seal, and replace defective parts as required.

If the upper and middle motor housings (17 and 22) were separated at disassembly, install a new O-ring (19) and secure the motor housings together with the hardware (51 and 52). Coat the threads

of the studs (50) with 'Never-Seez' or equivalent compound, and torque the nuts evenly in a cross sequence to 20 ft. lbs. (240 in. lbs. or 2,8 m. kg.).

Thoroughly clean the inside of the motor housings (17 and 22) with fresh solvent. The interior **must** be dry and free of dirt or lint.

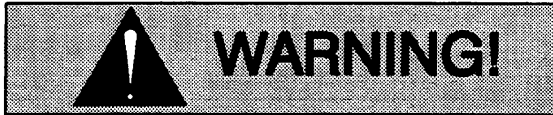

**Most cleaning solvents are toxic and flammable. Use them only in a well ventilated area free from excessive heat, sparks, and flame. Read and follow all precautions printed on solvent containers.**

After the motor housings are thoroughly cleaned, position them on a flat surface with the upper motor housing down. Do not unwrap the stator (53) until the motor housing has been prepared for stator installation. The stator **must** be kept clean and dry. When handling the stator, do not set it on the end windings. Lay it on its side and block it from rolling.

Test the new stator as indicated in **Electrical Testing** in TROUBLESHOOTING, Section D, to ensure that no damage has occurred during transit or handling.

#### NOTE

*Remove any drops of varnish from the ends of the stator before installation to ensure proper stack-up height when assembled.*

Position an expandable tool, such as a split disc, approximately 2 inches down inside the stator, and expand it tightly and squarely on the I.D. Attach a lifting device to the lifting eye of the tool, and carefully lift the assembly. Take care not to damage the stator end turns. Slip a sleeve over the stator leads, or tape them together to protect them during installation.

#### NOTE

*Stator installation involves application of heat to the upper and middle motor housings. This must be done quickly to promote efficient installation, allowing the stator to slide into the motor housings before the housings cool.*

Heat the motor housings with a torch to expand them enough for the stator to be installed; when heating the housings, **make sure** that the stator is clear to avoid a fire hazard, or damage to the windings. Apply heat evenly to the outside of the housings; excessive heat is not required.

When the motor housings are sufficiently heated, position the stator so that the leads are in line with the terminal opening, and carefully lower the stator into the motor housings until fully seated against the upper motor housing shoulder. Be careful not to damage the stator lead insulation during reassembly. If the stator "cocks" in the motor housing, remove it and try again.

After the stator is fully and squarely seated on the upper motor housing shoulder, remove the expandable disc tool and untape or remove the protective sleeve from the stator leads. Lock the stator in place by torquing the setscrews (21) to 7.5 ft. lbs. (90 in. lbs. or 1 m. kg.). Apply 'Loctite Pipe Sealant With Teflon No. 592' or equivalent on the threads of the pipe plugs (20), and install them in the motor housing.

Cover the motor housing with a clean, lint-free cloth while the rotor is being assembled.

#### Shaft And Rotor Installation

(Figure C-1)

Inspect the rotor shaft for damaged threads, scoring in the seal area, and a nicked or damaged keyway. If the bearings were removed, inspect the bearing areas for scoring or galling. Remove nicks and burrs with a fine file or emery cloth. Inspect the rotor area for separated laminations. If the shaft is bent or damaged, or if the laminations are separated, replace the shaft and rotor (a single assembly).

If the snap ring (15) was removed, install it in the groove in the rotor shaft.

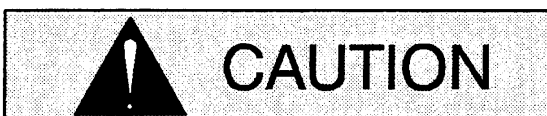

To prevent damage during removal from the shaft, it is recommended that bearings be cleaned and inspected **in place**. It is **strongly** recommended that the bearings



be replaced **any** time the shaft and rotor assembly is removed.

The bearings may be heated to ease installation. An induction heater, hot oil bath, electric oven, or hot plate may be used to heat the bearings. Bearings should **never** be heated with a direct flame or directly on a hot plate.

#### NOTE

*If a hot oil bath is used to heat the bearings, both the oil and the container must be **absolutely** clean. If the oil has been previously used, it must be **thoroughly** filtered.*

Heat the bearings to a uniform temperature **no higher than 250°F (120°C)**, and slide the bearings

onto the shaft, one at a time, until they are fully seated. This should be done quickly, in one continuous motion, to prevent the bearings from cooling and sticking on the shaft.



**Use caution when handling hot bearings to prevent burns.**

#### NOTE

*Position the lower bearing (14) on the shaft as indicated by the following illustration.*

#### INSTALLATION OF SKF 5200 AND 5300 SERIES BEARINGS

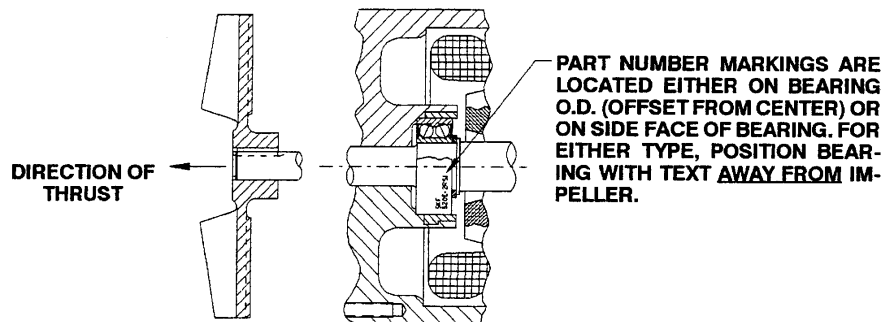

**NOTE:**  
THIS BEARING IS MANUFACTURED WITH TWO SEALS OR SHIELDS. WHEN INSTALLED ON THE SHAFT, THE MANUFACTURER'S PART NUMBER DESCRIPTION (LOCATED ON SIDE FACE OF BEARING OR BEARING O.D.) MUST BE LOCATED WITH THE TEXT **AWAY FROM THE IMPELLER**.

**Figure C-3. Bearing Installation**

After the bearings have been installed and allowed to cool, check to ensure that they have not moved out of position in shrinking. If movement has occurred, use a suitably sized sleeve and a press to reposition the bearings against the shaft shoulders.

If heating the bearings is not practical, use a suitably sized sleeve, and an arbor (or hydraulic) press to install the bearings on the shaft.



When installing the bearings onto the shaft, **never** press or hit against the outer

race, balls, or ball cage. Press **only** on the inner race.

Install the O-ring (13) on the lower motor housing, and slide the housing over the lower bearing until the bearing seats squarely in the housing bore. Secure the lower motor housing with the retaining ring (16).

Use **fresh** solvent to clean the bearing seating bore of the upper motor housing (22). Lower the assembled housing, rotor shaft, and bearings into the middle and upper motor housings until the upper bearing seats squarely in the bearing bore.

Tap the lower motor housing with a soft-faced mallet until fully seated in the middle motor housing. **Be careful** not to cut the O-ring (13).

Coat the threads of the studs (55) with 'Never-Seez' or equivalent compound. Install the hardware (56 and 57), and torque the nuts evenly in a cross sequence to 20 ft. lbs. (240 in. lbs. or 2,8 m. kg.).

Apply a light coating of oil to the O-ring (24), and install it on the upper motor housing. Slide the pump casing (18) over the assembled motor until it seats against the O-ring and upper motor housing shoulder.

Refer to **PUMP END REASSEMBLY**, and reassemble the pump end components.

### Power Cable Reassembly

(Figure C-1)

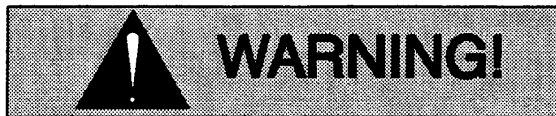

**The electrical power used to operate this pump is high enough to cause injury or death. Make certain that the control handle on the control box is in the off position and locked out, or that the power supply to the control box has been otherwise cut off and locked out, before attempting to open or service the pump assembly. Tag electrical circuits to prevent accidental startup. Obtain the services of a qualified electrician, and refer to the wiring diagram(s) in INSTALLATION, Section B, to make electrical connections.**

Clean the exterior of the power cable with warm water and mild detergent, and check for obvious physical damage. Check the cable for continuity and insulation resistance (see **Electrical Testing in TROUBLESHOOTING**). Do not attempt repairs except to cut off either end of the cable; **splicing is not recommended**. Reinstall any wire tags or terminals which may have been removed.

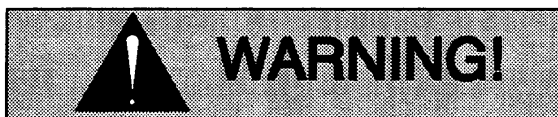

**Never attempt to alter the length or repair any power cable with a splice. The**

**pump motor and cable must be completely waterproof. Injury or death may result from alterations.**

Use oil to lightly lubricate the outside of the pump power cable (36) and the bore of the terminal housing (45) and the I.D. of the rubber cable grip bushing (45) for ease of assembly. Slide the hose clamp (37) onto the power cable. Compress the wire mesh on the cable grip assembly, and slide it onto the cable, allowing approximately 1 ft. (304,8 mm) of cable to extend beyond the mesh. Slide the rubber cable grip bushing and cable grip body onto the cable. Apply 'Loctite Pipe Sealant With Teflon No. 592' or equivalent compound on the tapered pipe threads of the cable grip body.

Feed the pump power cable leads into the terminal housing (45), and screw the cable grip body into the threaded housing bore until tight. Slide the cable grip bushing down the power cable into the tapered top of the grip body. **Be sure** there is sufficient cable lead length to permit wire connection, and that the trimmed end of the outer cable insulation is recessed approximately 1/8 inch (3.2 mm) in the bottom of the grip body. This creates a reservoir in the bottom of the cable grip into which the power cable sealant can be applied.

Tighten the cable grip body into the terminal housing with a flat side next to the allen head setscrew (41). Using an allen wrench, install the setscrew and tighten it down approximately half way. This will prevent the cable grip body from working loose.

Compress the wire mesh, and slide it down the cable until it seats on top of the rubber bushing. Tighten the cable grip nut on the cable body. Slide the hose clamp (37) down over the cable grip and tighten.

Connect the green ground lead and yellow ground check lead to the terminal housing (45). Secure the leads with the hardware (46 and 47). These two wires **must** be connected to separate points in the terminal housing. **Be sure** the terminals make good contact with the housing.

### NOTE

*Both the power cable and motor conductor leads should be tinned prior to reassembly.*

## Sealing Terminal Housing Connections

(Figure C-1)



**Do not attempt to operate this pump unless the power cable leads are properly sealed in the terminal housing. Moisture entering the terminal housing could cause a short circuit, resulting in pump damage and possible serious injury or death to personnel.**

The cable leads **must** be sealed in the cable grip body to prevent moisture from entering the motor. When shipped from the factory, the power cable leads were sealed in the cable grip body and terminal housing with silicone adhesive. If a replacement cable is being installed, the power cable must be sealed in the terminal housing.



Use **only** Dow-Corning 737 Silicone Adhesive (see the Parts List Manual for the part number) or potting compound for sealing terminal housing connections. Use of unapproved sealing products will void the pump warranty.

To seal the power cable leads, hold the terminal housing upside-down, and use silicone around the power cable leads. The power cable leads **must be totally sealed** against moisture.

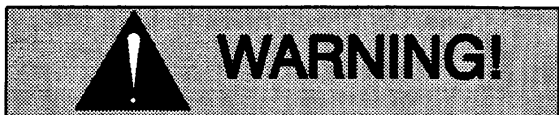

**All air pockets, voids or gaps in the silicone sealant must be removed to ensure a water-tight seal in the terminal housing. Otherwise, moisture entering the terminal housing could cause a short circuit, resulting in pump damage and possible serious injury or death to personnel.**

Do not apply more than a .25" thick layer. Allow the adhesive to cure for at least one hour before securing the terminal housing to the motor housing.

## Terminal Housing And Power Cable Installation

(Figure C-1)

Install a new O-ring (48) on the terminal housing. Refer to the wiring diagram in **INSTALLATION**, Section B, then connect the correct power cable leads to the stator leads with the connectors (49). **Be sure** the orange and blue cable leads are connected to the red coded (thermal overload) stator leads. After installing the connectors, wrap each connection with underwater tape (G-R part number 18666-068) to seal it and prevent the connector from working loose. Start the tape between the connectors and double back, then stretch the tape and wrap it around all of the leads and connectors.

Install the terminal housing in the motor housing, and secure with the hardware (34 and 35). Be careful not to cut or damage the O-ring (48). Tighten the capscrews evenly and alternately around the terminal housing, and torque them to 11 ft. lbs. (132 in. lbs. or 1.5 m. kg.).

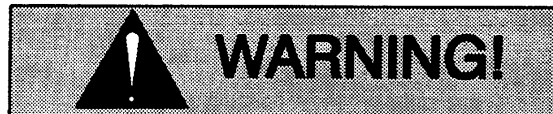

**The cable grip must be retained to the terminal housing as follows to retain permissibility for this equipment. Failure to seal the parts as specified may result in explosion.**

**Make sure** the cable grip body is tight in the terminal housing, and secure it to the terminal housing as follows (see Figure C-4).

- a. There are two tapped holes in the terminal housing located 90° apart. One hole will be used for installing the long locking setscrew (44); the other will be plugged with the short setscrew (41). Apply 'Loctite Pipe Sealant With Teflon No. 592' to **both** setscrews before installation.

**Make sure** the cable grip body is tight in the terminal housing. Note the location of the tapped hole which is blocked by the hex body. Unscrew the hex body until the hole is clear, and install the small setscrew (41).

Retighten the cable grip body, and install the longer setscrew (44) which locks the body in place.

- b. Drill a 1/16 inch (1.6 mm) diameter hole (B) in the cable grip body approximately 45° counterclockwise from hole A in the terminal housing. If the old cable grip is being reused, the

existing hole may be reused if it is in the correct location.

- c. Insert the seal wire (43) through hole B and equalize the wire length. Twist the wire ends approximately 10 turns and insert one end of the wire through hole A. Draw tight and twist the wire ends approximately 10 turns.

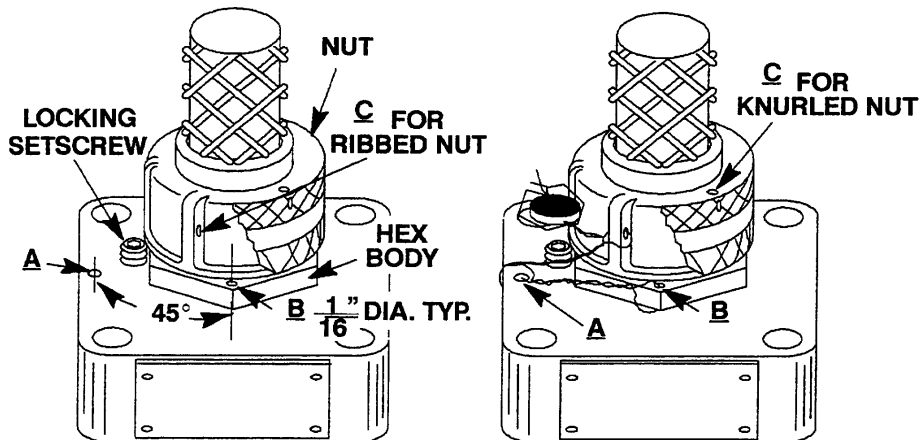

**Figure C-4. Safety Seal Installation**

- d. **Make sure** the cable grip nut is tight. Drill a 1/16 inch (1.6 mm) diameter hole (C) through the flange on the cable grip adjacent to hole B in the hex body.
- e. Insert one end of the twisted wire through hole C and draw tight. Twist the ends two turns and push them through the lead seal (42).
- f. Wrap the ends of the wires once around the twisted length from A to C from opposite directions, and push the wire ends through the lead seal again. Clamp the seal to secure the wire ends.

## FINAL ASSEMBLY

### (Figure C-1)

If the hoist bail (29) was removed, install the bushings (25) and secure the bail to the motor housing (22) with the hardware (26, 27 and 28).

If the discharge flange (32) was removed from the motor housing, replace the discharge flange gas-

ket (33). Apply 'Never-Seez' or equivalent compound on the flange studs, and secure the flange with the nuts (31).

Connect the discharge hose, and reposition the pump. If rigid piping or long hose is used, reposition the pump then connect the piping.

## VACUUM TESTING

To ensure the water-tight integrity of the pump, it is recommended that the motor and seal cavities be vacuum tested any time the seal(s) and/or motor are serviced.

Use a manometer with a range of 30 to 0 to 30 inches of mercury to perform the test. **Do not** use a vacuum gauge. Vacuum gauges are not sensitive enough to detect minor leaks.

It is recommended that a vacuum pump be used to draw the vacuum on the cavities. If a vacuum pump is not available, a compressor/venturi system may be used, see Figure C-5.

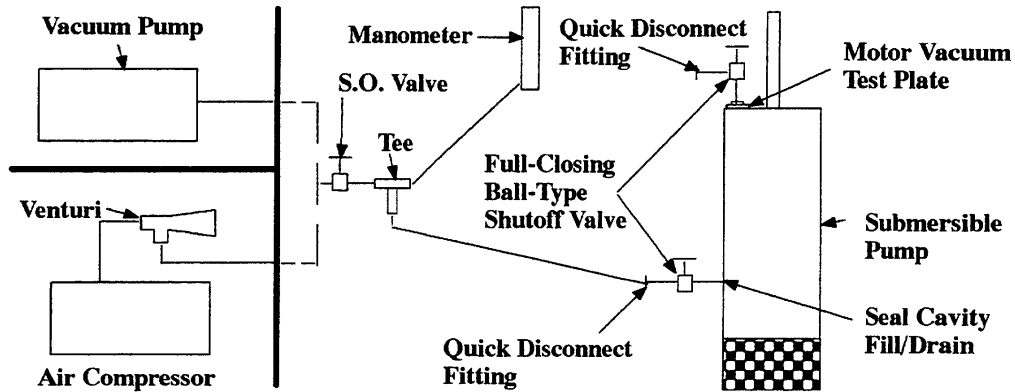

Figure C-5. Vacuum Test System

**Seal Cavity Testing**

If the water-tight integrity of the motor was not disturbed during disassembly, the seal cavity can be tested without testing the motor.

Drain **all** of the oil from the seal cavity before performing the test. Oil within the cavity will be drawn into the system, resulting in damage to the vacuum pump or manometer.

See Figure C-5 and connect the vacuum pump or compressor/venturi system directly to the pump at the hole for the seal cavity drain plug (47).

Draw the seal cavity vacuum down to **not more than 30 In. Hg.** and hold for 10 minutes. If no change in vacuum reading is detected, proceed with **LUBRICATION**.

30 In. Hg. Lower vacuum can cause separation of the seal faces and/or unseating of the upper seal stationary seat, resulting in seal leakage.

**Seal And Motor Cavity Testing**

Connect the vacuum pump or compressor/venturi system to the pump as shown in Figure C-5.

If the compressor/venturi cannot draw the higher vacuum level shown in Table C-1, draw the motor cavity vacuum down as far as the system will allow, then draw the seal cavity down so the differential between the two cavities is the same as the differential between the vacuum readings shown in the table.



**Do not draw the seal cavity vacuum below**

To vacuum test the motor cavity, the terminal housing assembly must be replaced with a test plate. Make the test plate as shown in Figure C-6 below, then proceed with vacuum testing.

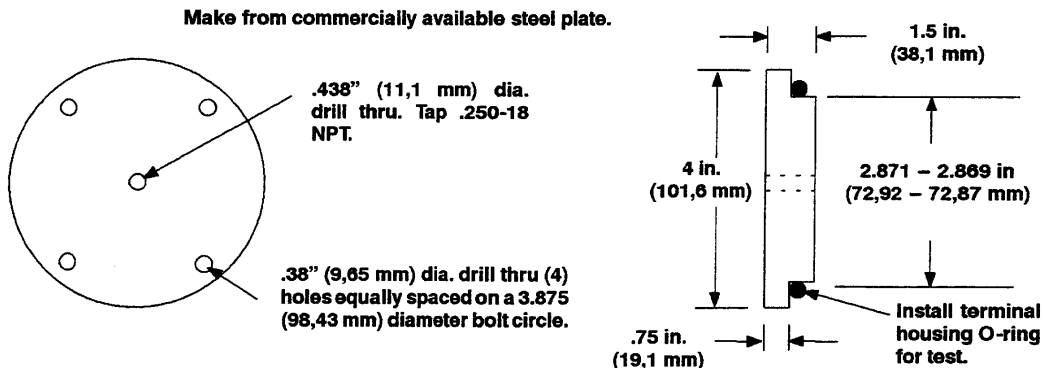

Figure C-6. Motor Vacuum Test Plate

Install full-closing ball-type shutoff valves with quick-disconnect fittings in the pipe plug holes in both the motor and seal cavities. Test the motor cavity for its full duration first, then use the shutoff valve to maintain the motor cavity vacuum while testing the seal cavity. The seal cavity vacuum **must** be higher than the vacuum in the motor cavity to prevent separation of the seal faces or unseating the stationary seal seat between the seal and motor cavities.

Figure C-6 shows a simple schematic for setting up either a vacuum pump or a venturi/compressor test system.

Table C-1 shows the vacuum to be drawn on each cavity, and the duration to maintain each vacuum reading. **Any** change in vacuum reading during the test indicates a leak which **must** be identified and corrected before putting the pump back into service.

**Table C-1. Vacuum Test Data**

Pump Model	Motor Cavity Vacuum (In. Hg.)	Duration (Minutes)	Seal Cavity Vacuum (In. Hg.)	Duration (Minutes)
SM4K	30	2	20	1

**LUBRICATION**

**Seal Cavity**

Check the oil level in the seal cavity before initial startup, after the first two weeks of operation, and every month thereafter.

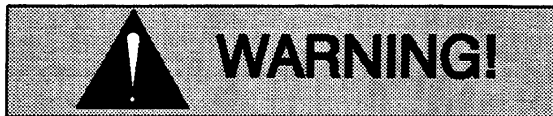

**Check the oil level only when the pump is cool. If the oil level plug is removed when the pump is hot, pressure in the seal cavity can cause hot oil to be ejected as the plug is removed.**

To check the seal cavity oil, lay the pump on its side with the level plug up. Remove the plug, and screw a short 1/4 inch NPT nipple into the hole. Plug the open end of the nipple with your finger. Tip the pump upright, drain off a small amount of oil into a transparent cup, and lay the pump on its side again. If the oil level is abnormally low, or the color milky or dark, refer to **Draining Oil From Seal Cavity** in this section for instructions and troubleshooting tips. If the oil is clear, remove the

nipple and top off the seal cavity with oil. Apply 'Loctite Pipe Sealant With Teflon No. 592.' or equivalent to the threads of the pipe plug, before re-installing the plug.

When lubricating a dry (overhauled) pump, see Table C-2 for the amount of lubricant and Table C-3 for lubricant specifications.

The grade of lubricant used is critical to the operation of this pump. Use uninhibited transformer oil as specified in the following table.

**Table C-2. Oil Quantity**

Pump Model	Seal Cavity
SM4K1	32 ounces (1 liter)

**Motor Housing Cavity**

The motor is cooled by the constant flow of the liquid being discharged through internal passages surrounding the motor housing. The rotor shaft bearings are permanently sealed, and no additional lubrication is required.

Table C-3. Pump Oil Specifications

Specifications:	
Type .....	Premium high viscosity index, anti-wear hydraulic oil
Viscosity @ 100°F (38°C) .....	110 to 155
Viscosity @ 210°F (99°C) .....	40 to 50
Dielectric .....	26,000 (volts-min)
Recommended supplier:	
Gulf Oil Company .....	Gulf Harmony HVI AW 26
Acceptable alternate suppliers:	
Gulf Oil Company .....	Gulf Harmony 32 AW
Texas Oil Company .....	Rando HD 32 or HD AZ 32
Sun Oil Company .....	Sunvis 816 or 916
BP (Also Boron) .....	Energol-HLP 32
Shell Oil Company .....	Tellus 32, Tellus T-23 or T32
ARCO .....	Duro 32
Exxon (Also Esso) .....	Nuto H 32
Petro-Canada .....	Harmony HVI 22

**For U.S. and International Warranty Information,  
Please Visit [www.grpumps.com/warranty](http://www.grpumps.com/warranty)  
or call:  
U.S.: 419-755-1280  
International: +1-419-755-1352**

**For Canadian Warranty Information,  
Please Visit [www.grcanada.com/warranty](http://www.grcanada.com/warranty)  
or call:  
519-631-2870**