

**INSTALLATION, OPERATION,  
AND MAINTENANCE MANUAL**  
WITH PARTS LIST



**80 SERIES PUMP**

MODEL
<b>81 1/2P47A-E2 1P</b>

**THE GORMAN-RUPP COMPANY • MANSFIELD, OHIO**

[www.grpumps.com](http://www.grpumps.com)

GORMAN-RUPP OF CANADA LIMITED • ST. THOMAS, ONTARIO, CANADA Printed in U.S.A.

©1984 The Gorman-Rupp Company

Register your new  
Gorman-Rupp pump online at  
**[www.grpumps.com](http://www.grpumps.com)**

Valid serial number and e-mail address required.

**RECORD YOUR PUMP MODEL AND SERIAL NUMBER**

Please record your pump model and serial number in the spaces provided below. Your Gorman-Rupp distributor needs this information when you require parts or service.

Pump Model: \_\_\_\_\_

Serial Number: \_\_\_\_\_

# TABLE OF CONTENTS

<b>INTRODUCTION</b> .....	<b>PAGE I – 1</b>
<b>SAFETY - SECTION A</b> .....	<b>PAGE A – 1</b>
<b>INSTALLATION – SECTION B</b> .....	<b>PAGE B – 1</b>
Pump Dimensions .....	PAGE B – 1
PREINSTALLATION INSPECTION .....	PAGE B – 1
POSITIONING PUMP .....	PAGE B – 2
Lifting .....	PAGE B – 2
Mounting .....	PAGE B – 2
SUCTION AND DISCHARGE PIPING .....	PAGE B – 2
Materials .....	PAGE B – 2
Line Configuration .....	PAGE B – 2
Connections to Pump .....	PAGE B – 3
Gauges .....	PAGE B – 3
SUCTION LINES .....	PAGE B – 3
Fittings .....	PAGE B – 3
Strainers .....	PAGE B – 3
Sealing .....	PAGE B – 3
Suction Lines In Sumps .....	PAGE B – 3
Suction Line Positioning .....	PAGE B – 4
DISCHARGE LINES .....	PAGE B – 5
Siphoning .....	PAGE B – 5
Valves .....	PAGE B – 5
Bypass Lines .....	PAGE B – 5
ELECTRICAL CONNECTIONS .....	PAGE B – 5
<b>OPERATION – SECTION C</b> .....	<b>PAGE C – 1</b>
PRIMING .....	PAGE C – 1
STARTING .....	PAGE C – 1
OPERATION .....	PAGE C – 2
Lines With a Bypass .....	PAGE C – 2
Lines Without a Bypass .....	PAGE C – 2
Leakage .....	PAGE C – 2
Liquid Temperature And Overheating .....	PAGE C – 2
Strainer Check .....	PAGE C – 2
Pump Vacuum Check .....	PAGE C – 2
STOPPING .....	PAGE C – 3
Cold Weather Preservation .....	PAGE C – 3
<b>TROUBLESHOOTING – SECTION D</b> .....	<b>PAGE D – 1</b>
PREVENTIVE MAINTENANCE .....	PAGE D – 3
<b>PUMP MAINTENANCE AND REPAIR - SECTION E</b> .....	<b>PAGE E – 1</b>
STANDARD PERFORMANCE CURVE .....	PAGE E – 1
PARTS LIST:	
Pump Model .....	PAGE E – 3

**TABLE OF CONTENTS**  
**(continued)**

PUMP AND SEAL DISASSEMBLY AND REASSEMBLY .....	PAGE E – 4
Pump Casing and Vane Plate Removal .....	PAGE E – 4
Impeller Removal .....	PAGE E – 4
Seal Removal .....	PAGE E – 5
Seal Reassembly and Installation .....	PAGE E – 5
Impeller Installation .....	PAGE E – 6
Vane Plate and Pump Casing Installation .....	PAGE E – 7
Final Pump Assembly .....	PAGE E – 7
LUBRICATION .....	PAGE E – 7
Seal Assembly .....	PAGE E – 7

## INTRODUCTION

**Thank You** for purchasing a Gorman-Rupp pump. **Read this manual** carefully to learn how to safely install and operate your pump. Failure to do so could result in personal injury or damage to the pump.

This pump is an 80 Series, semi-open impeller, self-priming centrifugal model without a suction check valve. It is close-coupled to a 2 H.P., single phase, totally enclosed, fan-cooled electric motor. The basic material of construction for wetted parts is fiberglass reinforced polyester (Valox® grade 420).

The pump is designed for handling water and most water-soluble herbicides and pesticides, as well as certain chemicals and waste solutions within specified temperatures and concentrations. Consult the factory for information about your specific application or for a copy of our chemical compatibility guide. This pump is **not** recommended for handling volatile or flammable liquids.

For information or technical assistance on the motor, contact the motor manufacturer's local dealer or representative.

This manual will alert personnel to known procedures which require special attention, to those which could damage equipment, and to those which could be dangerous to personnel. However, this manual cannot possibly anticipate and provide detailed precautions for every situation that might occur during maintenance of the unit. Therefore, it is the responsibility of the owner/maintenance personnel to ensure that **only** safe, established maintenance procedures are used, and that any procedures not addressed in this manual are performed **only** after establishing that neither personal safety nor pump integrity are compromised by such practices.

If there are any questions regarding the pump or its application which are not covered in this manual or in other literature accompanying this unit, please contact your Gorman-Rupp distributor, or:

**The Gorman-Rupp Company**  
**P.O. Box 1217**  
**Mansfield, Ohio 44901-1217**  
**Phone: (419) 755-1011**

or:

**Gorman-Rupp of Canada Limited**  
**70 Burwell Road**  
**St. Thomas, Ontario N5P 3R7**  
**Phone: (519) 631-2870**

The following are used to alert maintenance personnel to procedures which require special attention, to those which could damage equipment, and to those which could be dangerous to personnel:



**Immediate hazards which WILL result in severe personal injury or death. These instructions describe the procedure required and the injury which will result from failure to follow the procedure.**



**Hazards or unsafe practices which COULD result in severe personal injury or death. These instructions describe the procedure required and the injury which could result from failure to follow the procedure.**



Hazards or unsafe practices which COULD result in minor personal injury or product or property damage. These instructions describe the requirements and the possible damage which could result from failure to follow the procedure.

### NOTE

*Instructions to aid in installation, operation, and maintenance or which clarify a procedure.*

## SAFETY - SECTION A

This information applies to 80 Series electric motor driven pumps. Refer to the manual accompanying the motor before attempting to begin operation.

Because pump installations are seldom identical, this manual cannot possibly provide detailed instructions and precautions for each specific application. Therefore, it is the owner/installer's responsibility to ensure that applications not addressed in this manual are performed only after establishing that neither operator safety nor pump integrity are compromised by the installation.



Before attempting to open or service the pump:

1. Familiarize yourself with this manual.
2. Disconnect the incoming power to the motor and lock it out to ensure that the pump will remain inoperative.
3. Allow the pump to completely cool if overheated.
4. Check the temperature before opening any covers, plates, or plugs.
5. Close the suction and discharge valves.
6. Vent the pump slowly and cautiously.
7. Drain the pump.



This pump is designed to handle water and most water-soluble herbicides and pesticides, as well as certain chemicals and waste solutions within speci-

fied temperatures and concentrations. Do not attempt to pump volatile or flammable materials which may damage the pump or endanger personnel as a result of pump failure.



After the pump has been installed, make certain that the pump and all piping or hose connections are tight, properly supported and secure before operation.



Do not operate the pump against a closed discharge valve for long periods of time. If operated against a closed discharge valve, pump components will deteriorate, and the liquid could come to a boil, build pressure, and cause the pump casing to rupture or explode.



This pump is designed to handle materials which could cause illness or injury through direct exposure or emitted fumes. Wear protective clothing, such as rubber gloves, face mask and rubber apron, as necessary, before disconnecting or servicing the pump or piping.



Do not remove plates, covers, gauges, pipe plugs, or fittings from an overheated pump. Vapor pressure within the pump can cause parts being disengaged to be ejected with great force. Allow the pump to cool before servicing.

**WARNING!**

Do not install and operate a non-explosion proof motor in an explosive atmosphere. Install, connect, and operate the motor in accordance with the National Electric Code and all local codes. If there is a conflict between the instructions in the manual accompanying the unit and the National Electric Code or the applicable local code, the National or local code shall take precedence.

**WARNING!**

The electrical power used to operate this pump is high enough to cause injury or death. Obtain the services of a qualified electrician to troubleshoot, test and/or service the electrical components of this pump.

**CAUTION**

Pumps and related equipment must be installed and operated according to all national, local and industry standards.

## INSTALLATION – SECTION B

**Review all SAFETY information in Section A.**

Since pump installations are seldom identical, this section offers only general recommendations and practices required to inspect, position, and arrange the pump and piping.

Most of the information pertains to a standard **static lift** application where the pump is positioned above the free level of liquid to be pumped.

If installed in a **flooded suction application** where the liquid is supplied to the pump under pressure, some of the information such as mounting, line configuration, and priming must be tailored to the

specific application. Since the pressure supplied to the pump is critical to performance and safety, **be sure** to limit the incoming pressure to 50% of the maximum permissible operating pressure as shown on the pump performance curve (see Section E, Page 1).

For further assistance, contact your Gorman-Rupp distributor or the Gorman-Rupp Company.

**Pump Dimensions**

See Figure 1 for the approximate physical dimensions of this pump.

**OUTLINE DRAWING**

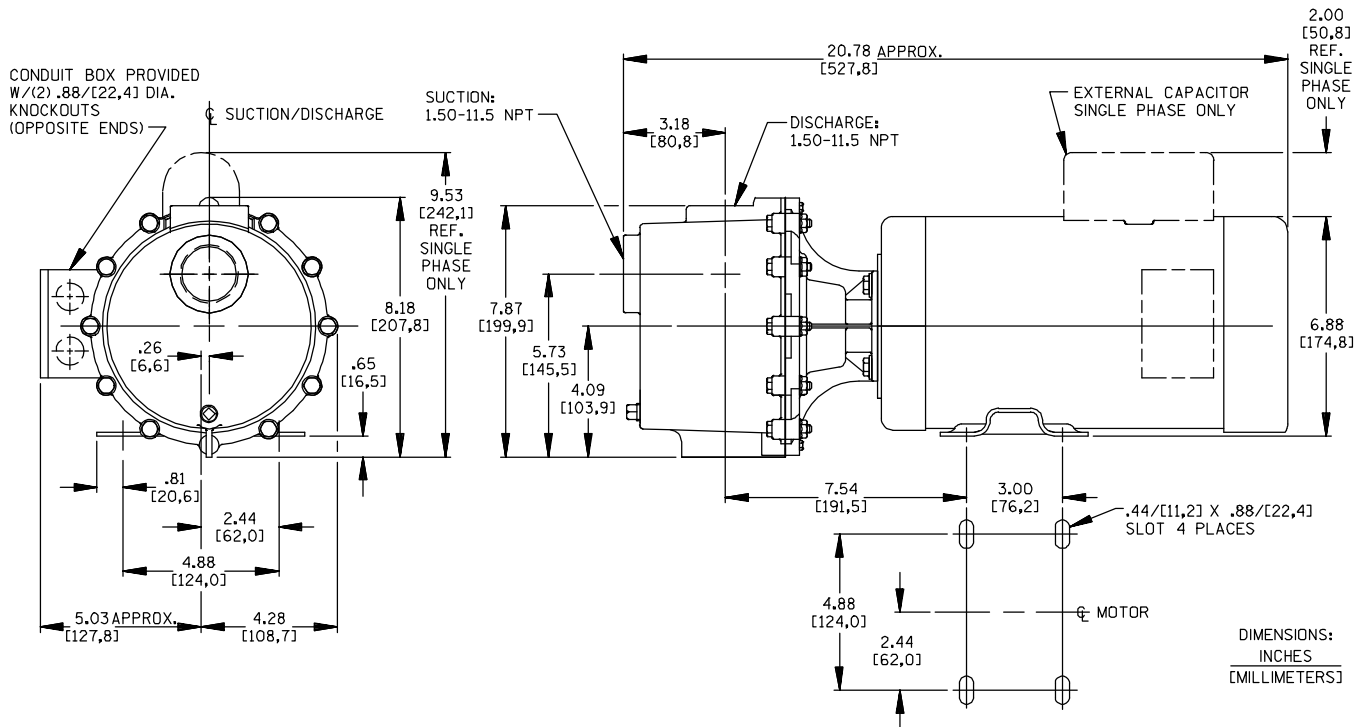

**Figure 1. Pump Model 81 1/2P47A-E2 1P**

**PREINSTALLATION INSPECTION**

The pump assembly was inspected and tested before shipment from the factory. Before installation, inspect the pump for damage which may have occurred during shipment. Check as follows:

- a. Inspect the pump and motor for cracks, dents, damaged threads, and other obvious damage.
- b. Check for and tighten loose attaching hardware. Since gaskets tend to shrink after dry-



ing, check for loose hardware at mating surfaces.

- c. Carefully read all tags, decals, and markings on the pump assembly, and perform all duties indicated.
- d. Check levels and lubricate as necessary. Refer to **LUBRICATION** in the **MAINTENANCE AND REPAIR** section of this manual and perform duties as instructed.
- e. If the pump and motor have been stored for more than 12 months, some of the components or lubricants may have exceeded their maximum shelf life. These **must be inspected or replaced** to ensure maximum pump service.



**The electrical power used to operate this pump is high enough to cause injury or death. Obtain the services of a qualified electrician to troubleshoot, test and/or service the electrical components of this pump.**

If the maximum shelf life has been exceeded, or if anything appears to be abnormal, contact your Gorman-Rupp distributor or the factory to determine the repair or updating policy. **Do not** put the pump into service until appropriate action has been taken.

## POSITIONING PUMP

### Lifting

Pump unit weights will vary depending on the mounting and drive provided. Check the shipping tag on the unit packaging for the actual weight, and use lifting equipment with appropriate capacity. Drain the pump and remove all customer-installed equipment such as suction and discharge hoses or piping before attempting to lift existing, installed units.



The pump assembly can be seriously damaged if the chains or cables used to lift and move the unit are improperly wrapped around the pump.



The pump casing, flanges and seal plate are made of fiberglass-reinforced polyester, which can crack under impact or shock. Take every precaution against dropping the pump or striking pump components.

### Mounting

Locate the pump in an accessible place as close as practical to the liquid being pumped. Level mounting is essential for proper operation.

The pump may have to be supported or shimmed to provide for level operation or to eliminate vibration.

## SUCTION AND DISCHARGE PIPING

Pump performance is adversely effected by increased suction lift, discharge elevation, and friction losses. See the performance curve on Page E-1 to be sure your overall application allows pump to operate within the safe operation range.

### Materials

Either pipe or hose maybe used for suction and discharge lines; however, the materials must be compatible with the liquid being pumped. If hose is used in suction lines, it must be the rigid-wall, reinforced type to prevent collapse under suction. Using piping couplings in suction lines is not recommended.

### Line Configuration

Keep suction and discharge lines as straight as possible to minimize friction losses. Make minimum use of elbows and fittings, which substan-

tially increase friction loss. If elbows are necessary, use the long-radius type to minimize friction loss.

Flexible connectors are required on suction and discharge connections in order to prevent piping loads.



The suction and discharge lines **must** be supported and connected to the pump with flexible connectors in order to prevent piping loads. **The pump warranty will be voided if flexible connectors are not used.**

### Connections to Pump

Before tightening a connecting flange, align it exactly with the pump port. Never pull a pipe line into place by tightening the flange bolts and/or couplings.

Lines near the pump must be independently supported to avoid strain on the pump which could cause excessive vibration, decreased bearing life, and increased shaft and seal wear. If hose-type lines are used, they should have adequate support to secure them when filled with liquid and under pressure.

### Gauges

Most pumps are drilled and tapped for installing discharge pressure and vacuum suction gauges. If these gauges are desired for pumps that are not tapped, drill and tap the suction and discharge lines not less than 18 inches (457,2 mm) from the suction and discharge ports and install the lines. Installation closer to the pump may result in erratic readings.

## SUCTION LINES

To avoid air pockets which could affect pump priming, the suction line must be as short and direct as possible. When operation involves a suction lift, the line must always slope upward to the pump from the source of the liquid being pumped; if the line

slopes down to the pump at any point along the suction run, air pockets will be created.

The suction line should not exceed 20 feet (6 meters) in length.

### Fittings

The use of plastic fittings to connect suction and discharge lines to the pump is recommended. Use a good grade of pipe sealant on the threads of the fittings. Draw the fittings up hand tight, then give them one full turn with a wrench.

Suction lines should be the same size as the pump inlet. If reducers are used in suction lines, they should be the eccentric type, and should be installed with the flat part of the reducers uppermost to avoid creating air pockets. Valves are not normally used in suction lines, but if a valve is used, install it with the stem horizontal to avoid air pockets.

### Strainers

If a strainer is furnished with the pump, be certain to use it; any spherical solids which pass through a strainer furnished with the pump will also pass through the pump itself.

If a strainer is not furnished with the pump, but is installed by the pump user, make certain that the total area of the openings in the strainer is at least three or four times the cross section of the suction line, and that the openings will not permit passage of solids larger than the solids handling capability of the pump.

This pump is designed to handle up to 9/16 inch (14,3 mm) diameter spherical solids.

### Sealing

Since even a slight leak will affect priming, head, and capacity, especially when operating with a high suction lift, all connections in the suction line should be sealed with pipe dope to ensure an air-tight seal. Follow the sealant manufacturer's recommendations when selecting and applying the pipe dope. The pipe dope should be compatible with the liquid being pumped.

### Suction Lines In Sumps

If a single suction line is installed in a sump, it should be positioned away from the wall of the

sump at a distance equal to 1-1/2 times the diameter of the suction line

If there is a liquid flow from an open pipe into the sump, the flow should be kept away from the suction inlet because the inflow will carry air down into the sump, and air entering the suction line will reduce pump efficiency.

If it is necessary to position inflow close to the suction inlet, install a baffle between the inflow and the suction inlet at a distance 1-1/2 times the diameter of the suction pipe. The baffle will allow entrained air to escape from the liquid before it is drawn into the suction inlet.

If two suction lines are installed in a single sump, the flow paths may interact, reducing the efficiency of one or both pumps. To avoid this, position the suction inlets so that they are separated by a dis-

tance equal to at least 3 times the diameter of the suction pipe.

**Suction Line Positioning**

The depth of submergence of the suction line is critical to efficient pump operation. Figure 2 shows recommended minimum submergence vs. velocity.

**NOTE**

*The pipe submergence required may be reduced by installing a standard pipe increaser fitting at the end of the suction line. The larger opening size will reduce the inlet velocity. Calculate the required submergence using the following formula based on the increased opening size (area or diameter).*

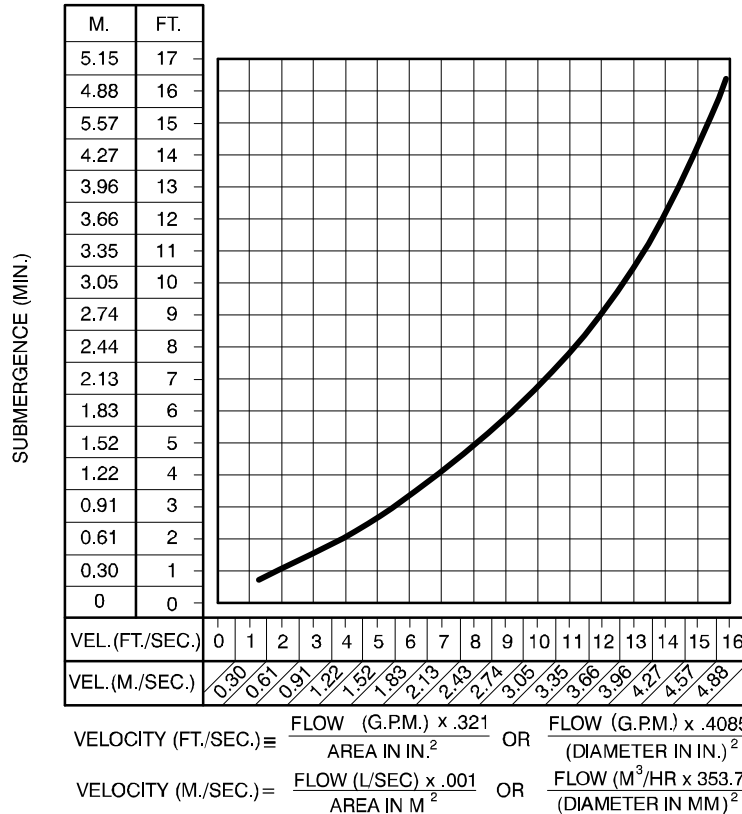

**Figure 2. Recommended Minimum Suction Line Submergence vs. Velocity**

## DISCHARGE LINES

### Siphoning

Do not terminate the discharge line at a level lower than that of the liquid being pumped unless a siphon breaker is used in the line. Otherwise, a siphoning action causing damage to the pump could result.

### Valves

A check valve in the discharge line is normally recommended, but it is not necessary in low discharge head applications.

If a throttling valve is desired in the discharge line, use a valve as large as the largest pipe to minimize friction losses. Never install a throttling valve in a suction line.

With high discharge heads, it is recommended that a throttling valve and a system check valve be installed in the discharge line to protect the pump from excessive shock pressure and reverse rotation when it is stopped.



If the application involves a high discharge head, gradually close the discharge throttling valve before stopping the pump.

### Bypass Lines

If a system check valve is used due to high discharge head, it may be necessary to vent trapped air from the top of the pump during the priming

process. This may be accomplished by installing a bypass line from the top of the pump, back to the source of liquid. The end of the bypass line must be submerged. The line must be large enough to prevent clogging, but not so large as to affect pump discharge capacity.

## ELECTRICAL CONNECTIONS

Before connecting the motor to the incoming power, check that the electrical service available matches the pump motor requirements stamped on the motor nameplate.



**The electrical power used to operate this pump is high enough to cause injury or death. Obtain the services of a qualified electrician to make all electrical connections.**



**Do not install and operate a non-explosion proof motor in an explosive atmosphere. Install, connect, and operate the motor in accordance with The National Electric Code and all local codes. If there is a conflict between the instructions in the manual accompanying the unit and The National Electric Code or the applicable local code, The National or local code shall take precedence.**

Refer to the following motor data before making electrical connections.

MODEL	VOLTAGE	PHASE	HP	Hz	RPM	F.L. AMPS
81 1/2P47A-E2 1P	115/230	1	2	60	3450	20.0/10.0

## OPERATION – SECTION C

Review all SAFETY information in Section A.

Follow the instructions on all tags, labels and decals attached to the pump.



This pump is designed to handle water and most water-soluble herbicides and pesticides, as well as certain chemicals and waste solutions within specified temperatures and concentrations. Do not attempt to pump volatile or flammable materials which may damage the pump or endanger personnel as a result of pump failure.



Do not install and operate a non-explosion proof motor in an explosive atmosphere. Install, connect, and operate the motor in accordance with the National Electric Code and all local codes. If there is a conflict between the instructions in the manual accompanying the unit and the National Electric Code or the applicable local code, the National or local code shall take precedence.



Pump speed and operating condition points must be within the continuous performance range shown on the curve (see Section E, Page 1).

### PRIMING

Install the pump and piping as described in **INSTALLATION**. Make sure that the piping connections are tight, and that the pump is securely mounted. Check that the pump is properly lubri-

cated (see **LUBRICATION** in **MAINTENANCE AND REPAIR**).

This pump is self-priming, but the pump should never be operated unless there is liquid in the pump casing.



Never operate this pump unless there is liquid in the pump casing. The pump will not prime when dry. Extended operation of a dry pump will destroy the seal assembly.

Add liquid to the pump casing when:

1. The pump is being put into service for the first time.
2. The pump has not been used for a considerable length of time.
3. The liquid in the pump casing has evaporated.

Once the pump casing has been filled, the pump will prime and reprime as necessary.



After filling the pump casing, reinstall and tighten the fill plug. Do not attempt to operate the pump unless all connecting piping is securely installed. Otherwise, liquid in the pump forced out under pressure could cause injury to personnel.

This pump is not equipped with a plug for filling the pump casing. To fill the pump, remove the discharge line and add approximately 1 gallon (3,8 liters) of clean liquid. Reconnect the discharge line and proceed with pump operation.

### STARTING

Consult the operations manual furnished with the motor.

## OPERATION

### Lines With a Bypass

Close the discharge throttling valve (if so equipped) so that the pump will not have to prime against the weight of the liquid in the discharge line. Air from the suction line will be discharged through the bypass line back to the wet well during the priming cycle. When the pump is fully primed and liquid is flowing steadily from the bypass line, open the discharge throttling valve. Liquid will then continue to circulate through the bypass line while the pump is in operation.

### Lines Without a Bypass

Open all valves in the discharge line and start the motor. Priming is indicated by a positive reading on the discharge pressure gauge or by a quieter operation. The pump may not prime immediately because the suction line must first fill with liquid. If the pump fails to prime within five minutes, stop it and check the suction line for leaks.

After the pump has been primed, partially close the discharge line throttling valve in order to fill the line slowly and guard against excessive shock pressure which could damage pipe ends, gaskets, sprinkler heads, and any other fixtures connected to the line. When the discharge line is completely filled, adjust the throttling valve to the required flow rate.

### Leakage

No leakage should be visible at pump mating surfaces, or at pump connections or fittings. Keep all line connections and fittings tight to maintain maximum pump efficiency.

### Liquid Temperature And Overheating

The **maximum** liquid temperature for this pump is 160° F (71° C). Do not apply it at a higher operating temperature.

Overheating can occur if operated with the valves in the suction or discharge lines closed. Operating against closed valves could bring the liquid to a boil, build pressure, and cause the pump to rup-

ture or explode. If overheating occurs, stop the pump and allow it to cool before servicing it. Refill the pump casing with cool liquid.



**Do not remove plates, covers, gauges, pipe plugs, or fittings from an overheated pump. Vapor pressure within the pump can cause parts being disengaged to be ejected with great force. Allow the pump to cool before servicing.**

### Strainer Check

If a suction strainer has been shipped with the pump or installed by the user, check the strainer regularly, and clean it as necessary. The strainer should also be checked if pump flow rate begins to drop. If a vacuum suction gauge has been installed, monitor and record the readings regularly to detect strainer blockage.

**Never** introduce air or steam pressure into the pump casing or piping to remove a blockage. This could result in personal injury or damage to the equipment. If backflushing is absolutely necessary, **liquid pressure** must be limited to 50% of the maximum permissible operating pressure shown on the pump performance curve (see Section E, Page 1).

### Pump Vacuum Check

Since this pump does not have a suction check valve, the discharge line must be fitted with a check valve if a pump vacuum reading is to be taken.

With the pump inoperative, install a vacuum gauge in the system, using pipe dope on the threads. Block the suction line and start the pump. At operating speed the pump should pull a vacuum of 20 inches (508 mm) or more of mercury. If it does not, check for air leaks in the seal, gasket, or discharge valve.

Open the suction line, and read the vacuum gauge with the pump primed and at operation speed. Shut off the pump. The vacuum gauge reading will immediately drop proportionate to static suction lift, and should then stabilize. If the vacuum reading

falls off rapidly after stabilization, an air leak exists. Before checking for the source of the leak, check the point of installation of the vacuum gauge.

## STOPPING

Never halt the flow of liquid suddenly. If the liquid being pumped is stopped abruptly, damaging shock waves can be transmitted to the pump and piping system. Close all connecting valves slowly.

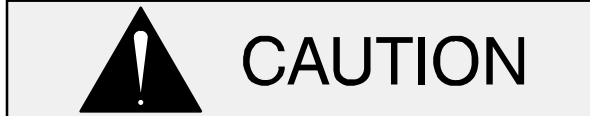

If the application involves a high discharge head, gradually close the discharge throttling valve before stopping the pump.

After stopping the pump, disconnect the incoming power to the motor and lock it out to ensure that the pump will remain inoperative.

## Cold Weather Preservation

In below freezing conditions, drain the pump to prevent damage from freezing. Also, clean out any solids by flushing with a hose. Operate the pump for approximately one minute; this will remove any remaining liquid that could freeze the pump rotating parts.

If the pump will be idle for more than a few hours, or if it has been pumping liquids containing a large amount of solids, drain the pump, and flush it thoroughly with clean water. To prevent large solids from clogging the drain port and preventing the pump from completely draining, insert a rod or stiff wire in the drain port, and agitate the liquid during the draining process. Clean out any remaining solids by flushing with a hose.

## TROUBLESHOOTING – SECTION D

Review all SAFETY information in Section A.



**Before attempting to open or service the pump:**

1. **Familiarize yourself with this manual.**
2. **Disconnect the incoming power to the motor and lock it out to ensure that the pump will remain inoperative.**
3. **Allow the pump to completely cool if overheated.**
4. **Check the temperature before opening any covers, plates, or plugs.**
5. **Close the suction and discharge valves.**
6. **Vent the pump slowly and cautiously.**
7. **Drain the pump.**

TROUBLE	POSSIBLE CAUSE	PROBABLE REMEDY
PUMP FAILS TO PRIME	<p>Not enough liquid in casing.</p> <p>Suction check valve contaminated or damaged.</p> <p>Air leak in suction line.</p> <p>Lining of suction hose collapsed.</p> <p>Leaking or worn seal or pump gasket.</p> <p>Suction lift or discharge head too high.</p> <p>Strainer clogged.</p>	<p>Add liquid to casing. See <b>PRIMING</b>.</p> <p>Clean or replace check valve.</p> <p>Correct leak.</p> <p>Replace suction hose.</p> <p>Check pump vacuum. Replace leaking or worn seal or gasket.</p> <p>Check piping installation and install bypass line if needed. See <b>INSTALLATION</b>.</p> <p>Check strainer and clean if necessary.</p>
PUMP STOPS OR FAILS TO DELIVER RATED FLOW OR PRESSURE	<p>Air leak in suction line.</p> <p>Lining of suction hose collapsed.</p> <p>Suction intake not submerged at proper level or sump too small.</p> <p>Impeller or other wearing parts worn or damaged.</p>	<p>Correct leak.</p> <p>Replace suction hose.</p> <p>Check installation and correct submergence as needed.</p> <p>Replace worn or damaged parts.</p> <p>Check that impeller is properly centered and rotates freely.</p>



TROUBLE	POSSIBLE CAUSE	PROBABLE REMEDY
<p>PUMP STOPS OR FAILS TO DELIVER RATED FLOW OR PRESSURE (cont.)</p>	<p>Leaking or worn seal or pump gasket.</p> <p>Impeller clogged.</p> <p>Low or incorrect voltage.</p> <p>No voltage at line side of circuit breaker.</p> <p>Suction lift or discharge head too high.</p>	<p>Check pump vacuum. Replace leaking or worn seal or gasket.</p> <p>Free impeller of debris.</p> <p>Measure control box voltage, both when pump is running and when shut off.</p> <p>Check power source for blown fuse, open circuit breaker or control box, broken lead, or loose connection.</p> <p>Check piping installation and install bypass line if needed. See <b>INSTALLATION</b>.</p>
<p>PUMP REQUIRES TOO MUCH POWER</p>	<p>Motor shaft or bearings defective.</p> <p>Discharge head too low.</p> <p>Liquid solution too thick.</p>	<p>Disassemble pump and check motor and bearings.</p> <p>Adjust discharge valve.</p> <p>Dilute if possible.</p>
<p>PUMP CLOGS FREQUENTLY</p>	<p>Discharge flow too slow.</p> <p>Suction check valve or foot valve clogged or binding.</p>	<p>Open discharge valve fully to increase flow rate, and run motor at maximum governed speed.</p> <p>Clean valve.</p>
<p>EXCESSIVE NOISE</p>	<p>Cavitation in pump.</p> <p>Pumping entrained air.</p> <p>Pump or drive not securely mounted.</p> <p>Impeller clogged or damaged.</p>	<p>Reduce suction lift and/or friction losses in suction line. Record vacuum and pressure gauge readings and consult local representative or factory.</p> <p>Locate and eliminate source of air bubble.</p> <p>Secure mounting hardware.</p> <p>Clean out debris; replace damaged parts.</p>

### PREVENTIVE MAINTENANCE

Since pump applications are seldom identical, and pump wear is directly affected by such things as the abrasive qualities, pressure and temperature of the liquid being pumped, this section is intended only to provide general recommendations and practices for preventive maintenance. Regardless of the application however, following a routine preventive maintenance schedule will help assure trouble-free performance and long life from your Gorman-Rupp pump. For specific questions concerning your application, contact your Gorman-Rupp distributor or the Gorman-Rupp Company.

Record keeping is an essential component of a good preventive maintenance program. Changes in suction and discharge gauge readings (if so

equipped) between regularly scheduled inspections can indicate problems that can be corrected before system damage or catastrophic failure occurs. The appearance of wearing parts should also be documented at each inspection for comparison as well. Also, if records indicate that a certain part (such as the seal) fails at approximately the same duty cycle, the part can be checked and replaced before failure occurs, reducing unscheduled down time.

For new applications, a first inspection of wearing parts at 250 hours will give insight into the wear rate for your particular application. Subsequent inspections should be performed at the intervals shown on the chart below. Critical applications should be inspected more frequently.

<b>Preventive Maintenance Schedule</b>					
<b>Item</b>	<b>Service Interval*</b>				
	<b>Daily</b>	<b>Weekly</b>	<b>Monthly</b>	<b>Semi-Annually</b>	<b>Annually</b>
General Condition (Temperature, Unusual Noises or Vibrations, Cracks, Leaks, Loose Hardware, Etc.)	I				
Pump Performance (Gauges, Speed, Flow)	I				
Bearing Lubrication		I			R
Seal Lubrication (And Packing Adjustment, If So Equipped)		I			R
V-Belts (If So Equipped)			I		
Air Release Valve Plunger Rod (If So Equipped)			I	C	
Front Impeller Clearance (Wear Plate)				I	
Rear Impeller Clearance (Seal Plate)				I	
Check Valve					I
Pressure Relief Valve (If So Equipped)					C
Pump and Driver Alignment					I
Shaft Deflection					I
Bearings					I
Bearing Housing					I
Piping					I
Driver Lubrication – See Mfgr’s Literature					I

**Legend:**  
 I = Inspect, Clean, Adjust, Repair or Replace as Necessary  
 C = Clean  
 R = Replace

\* Service interval based on an intermittent duty cycle equal to approximately 4000 hours annually. Adjust schedule as required for lower or higher duty cycles or extreme operating conditions.

## PUMP MAINTENANCE AND REPAIR - SECTION E

MAINTENANCE AND REPAIR OF THE WEARING PARTS OF THE PUMP WILL MAINTAIN PEAK OPERATING PERFORMANCE.

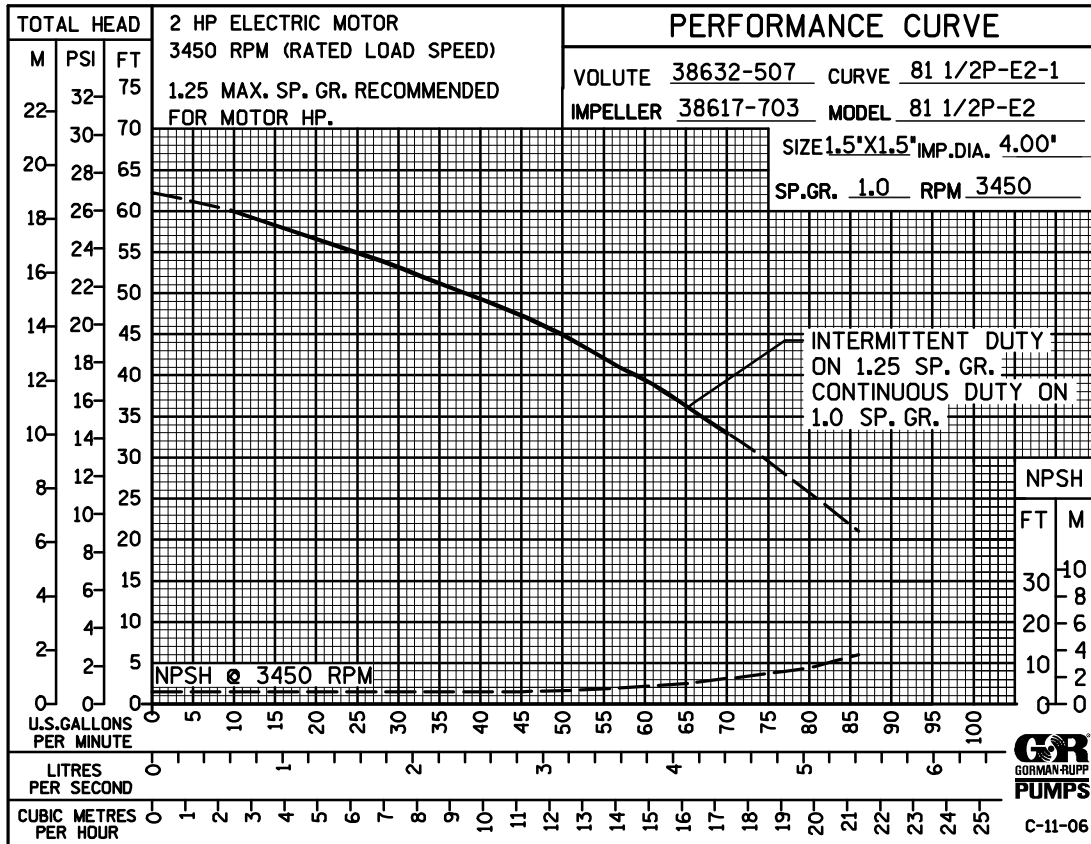

\* STANDARD PERFORMANCE FOR PUMP MODEL 81 1/2P47A-E2 1P

\* Based on 70°F (21°C) clear water at sea level with minimum suction lift. Since pump installations are seldom identical, your performance may be different due to such factors as viscosity, specific gravity, elevation, temperature, and impeller trim.

If your pump serial number is followed by an "N", your pump is **NOT** a standard production model. Contact the Gorman-Rupp Company to verify performance or part numbers.



Pump speed and operating condition points must be within the continuous performance range shown on the curve. Use caution not to overload the motor when handling liquids with a specific gravity greater than 1.0.

SECTION DRAWING

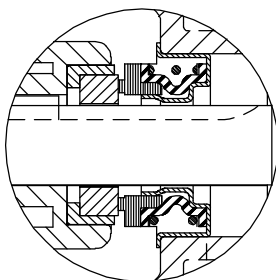

SEAL AREA DETAIL

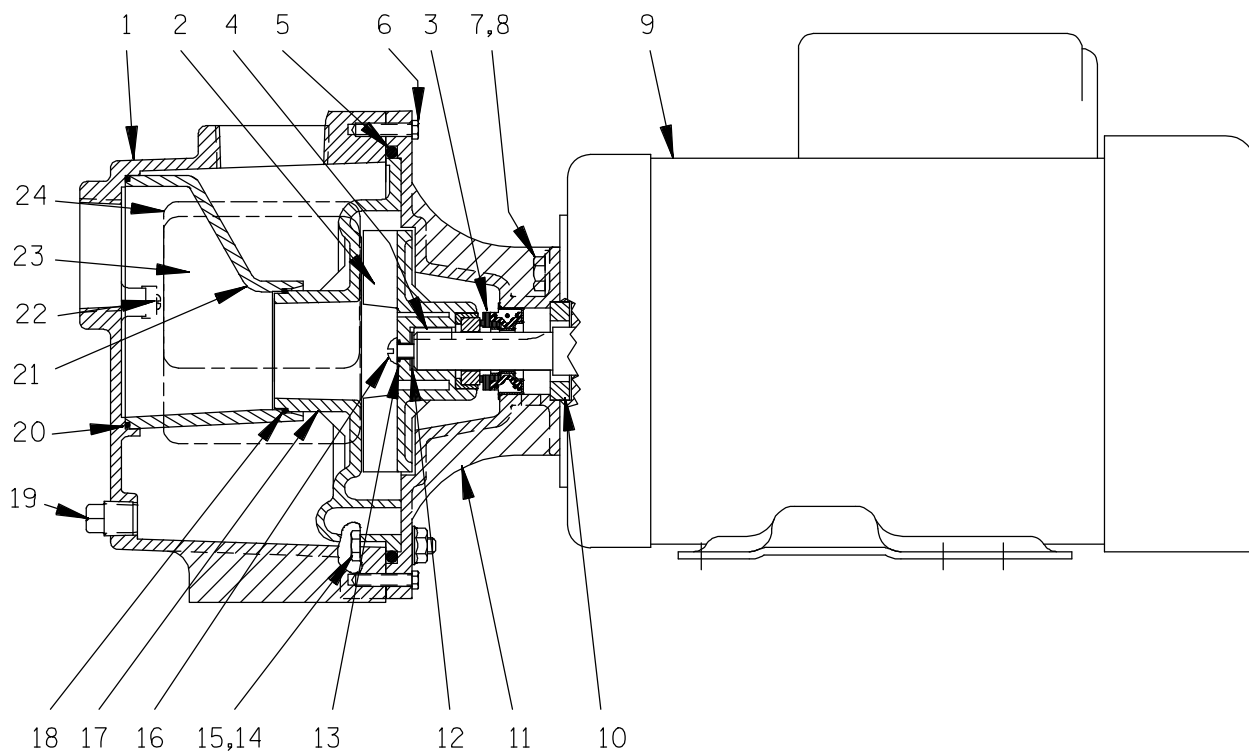

Figure 1. Pump Model 81 1/2P47A-E2 1P

**PARTS LIST**  
**Pump Model 81 1/2P47A-E2 1P**  
 (From S/N 801799 Up)

If your pump serial number is followed by an "N", your pump is **NOT** a standard production model. Contact the Gorman-Rupp Company to verify part numbers.

ITEM NO.	PART NAME	PART NUMBER	MAT'L CODE	QTY
1	PUMP CASING	38231-401	23200	1
2	* IMPELLER	38617-703	23200	1
3	* SEAL ASSEMBLY	25271-412	---	1
4	IMPELLER KEY	N0302-1/2	17000	1
5	* O-RING	25152-363	---	1
6	TAP SCREW	21287-596	---	2
7	HEX HD CAPSCREW	B0503S	17000	4
8	FLAT WASHER	KB05	17000	4
9	MOTOR, 2 H.P., 1P	28156-560	---	1
10	SPACER	31133-114	15030	1
11	INTERMEDIATE	38264-213	23200	1
12	* IMP ADJ SHIM SET	48261-032	---	1
13	* O-RING	25152-010	---	1
14	HEX HD CAPSCREW	B0405	17000	10
15	HEAVY NYLOCK NUT	21765-146	---	10
16	RD HD MACH SCREW	X0403S	17000	1
17	VANE PLATE	38632-507	23200	1
18	* VANE PLATE O-RING	25152-134	---	1
19	PIPE PLUG	26471-003	---	1
20	* FLOW GUIDE O-RING	25152-155	---	1
21	FLOW GUIDE	38354-018	23200	1
22	TAP SCREW	21287-584	---	2
23	NAME PLATE	38812-052	---	1
24	WARNING DECAL	38816-091	---	1
NOT SHOWN:				
	STRAINER	26841-007	---	1
	WARNING DECAL	2613FE	---	1
	WARNING DECAL	2613FF	---	1
	G-R DECAL	GR-02	---	1
	ROTATION DECAL	2613M	---	1
	INSTRUCTION TAG	38817-029	---	1
	SUCTION STICKER	6588AG	---	1
	DISCHARGE STICKER	6588BJ	---	1
OPTIONAL:				
	SUCTION NIPPLE	26523-303	---	1
	DISCHARGE ELBOW	26525-202	---	1
	REPAIR KIT (INCLUDES ALL * ITEMS ABOVE)	48221-019	---	1

\* INDICATES PARTS RECOMMENDED FOR STOCK

## PUMP AND SEAL DISASSEMBLY AND REASSEMBLY

Review all SAFETY information in Section A.

Follow the instructions on all tags, label and decals attached to the pump.

This pump requires little service due to its rugged, minimum-maintenance design. However, if it becomes necessary to inspect or replace the wearing parts, follow these instructions which are keyed to the sectional view (see Figure 1) and the accompanying parts list.

This manual will alert personnel to known procedures which require special attention, to those which could damage equipment, and to those which could be dangerous to personnel. However, this manual cannot possibly anticipate and provide detailed precautions for every situation that might occur during maintenance of the unit. Therefore, it is the responsibility of the owner/maintenance personnel to ensure that **only** safe, established maintenance procedures are used, and that any procedures not addressed in this manual are performed **only** after establishing that neither personal safety nor pump integrity are compromised by such practices.

Before attempting to service the pump, disconnect incoming power to the motor and lock it out to ensure that it will remain inoperative. Close all valves in the suction and discharge lines.

For motor disassembly and repair, consult the literature supplied with the motor, or contact your local motor representative.



**Before attempting to open or service the pump:**

1. **Familiarize yourself with this manual.**
2. **Disconnect the incoming power to the motor and lock it out to ensure that the pump will remain inoperative.**
3. **Allow the pump to completely cool if overheated.**

4. **Check the temperature before opening any covers, plates, or plugs.**
5. **Close the suction and discharge valves.**
6. **Vent the pump slowly and cautiously.**
7. **Drain the pump.**



**This pump is designed to handle materials which could cause illness or injury through direct exposure or emitted fumes. Wear protective clothing, such as rubber gloves, face mask and rubber apron, as necessary, before disconnecting or servicing the pump or piping.**

### Pump Casing and Vane Plate Removal

Before attempting to service the pump, remove the pump casing drain plug (25) and drain the pump. Clean the drain plug and wrap the threads with PTFE thread tape before reinstallation.

To service the impeller (2), vane plate (17) or seal assembly (3), disconnect the suction and discharge piping.

Remove the capscrews and nuts (14 and 15) and self-tapping screws (6) securing the pump casing (1) to the intermediate (11). Remove the pump casing by pulling straight away.

The flow guide (21) rarely requires removal or replacement, but if replacement is necessary, disengage the self-tapping screws. Pull the flow guide out of the pump casing and remove the O-ring (20).

Pull the vane plate off of the alignment pins on the intermediate. Remove the vane plate and casing O-rings (5 and 18).

### Impeller Removal

Insert a large screwdriver in the slot in the end of the motor shaft to prevent shaft rotation. Remove the impeller screw and O-ring (13 and 16) and pull the impeller off the shaft; retain the impeller key (4).

Inspect the impeller and replace it if cracked or badly worn. Slide the impeller adjusting shims (12) off the impeller shaft. Tie and tag the shims, or measure and record their thickness for ease of reassembly.

### Seal Removal

(Figures 1 and 2)

To remove the seal assembly (3), remove the rotating seat and element from the impeller cavity. Use a pair of stiff wires with hooked ends if necessary.

#### NOTE

*The stationary portion of the seal assembly is secured in the intermediate bore with “Loctite 30516 Aviation Gasket Sealant”. The seal cage can be damaged during removal; only remove the stationary seal components if replacement is required.*

Pry the remainder of the seal components from the intermediate as a unit. If the intermediate is removed, the seal components can be pressed out from the back of the intermediate.

To remove the intermediate, disengage the hardware (7 and 8) securing it to the motor (9).

### Seal Reassembly and Installation

(Figures 1 and 2)

Clean the seal cavity and shaft with a cloth soaked in fresh cleaning solvent.



**Most cleaning solvents are toxic and**

**flammable. Use them only in a well-ventilated area free from excessive heat, sparks, and flame. Read and follow all precautions printed on solvent containers.**

The seal is not normally reused because wear patterns on the finished faces cannot be realigned during reassembly. This could result in premature failure. If necessary to reuse an old seal in an emergency, **carefully** wash all metallic parts in fresh cleaning solvent and allow to dry thoroughly.

Handle the seal parts with extreme care to prevent damage. Be careful not to contaminate precision finished faces; even fingerprints on the faces can shorten seal life. If necessary, clean the faces with a non-oil based solvent and a clean, lint-free tissue. Wipe **lightly** in a concentric pattern to avoid scratching the faces.

Inspect the seal components for wear, scoring, grooves, and other damage that might cause leakage. Clean and polish the seal area of the shaft. Small nicks and burrs can be removed using a fine file or emery cloth. If any components are worn, replace the complete seal; **never mix old and new seal parts.**

If a replacement seal is being used, remove it from the container and inspect the precision-finished faces to ensure that they are free of any foreign matter.

To ease installation of the seal, lubricate the seal area of the shaft with water or a very **small** amount of oil, and apply a drop of light lubricating oil on the finished faces. Assemble the seal as follows, (see Figure 2).

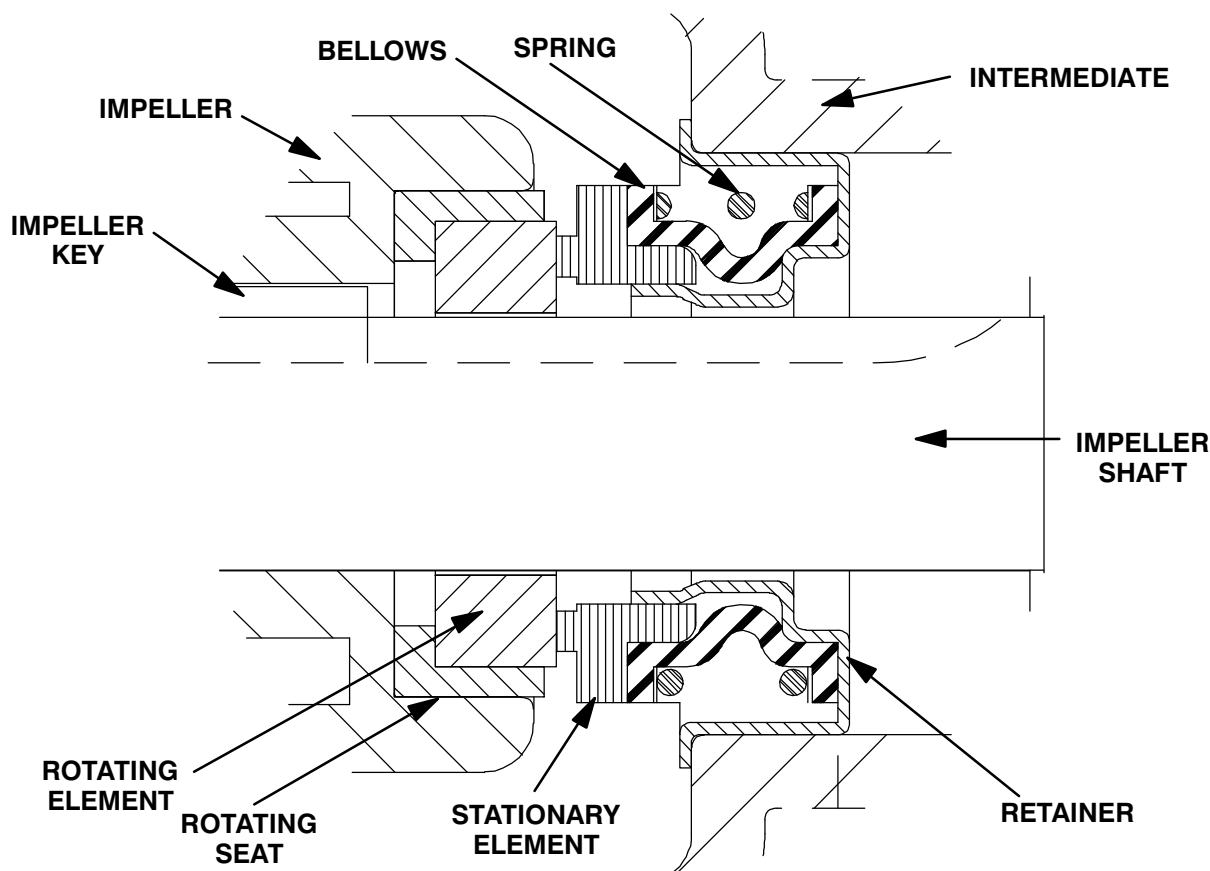

Figure 3. Seal Assembly



This seal is not designed for operation at temperatures above 160°F (71°C). Do not use at higher operating temperatures.

When pressing the stationary seal components into the intermediate, use hand pressure only. A push tube cut from a length of plastic pipe will aid in this installation. The I.D. of the push tube should be just large enough to slide over the stationary element and seat against the shoulder on the seal retainer.

Clean all of the old aviation gasket sealant from the intermediate bore before attempting to install the stationary seal components.

If removed at disassembly, slide the intermediate (11) over the shaft and spacer (10).

The intermediate is offset and not concentric to the shaft; be sure to position the intermediate against the motor with the drain holes in the neck of the

mounting flange pointed down. Secure the intermediate to the motor (9) with the hardware 97 and 8). Torque the capscrews (7) alternately to 55 in. lbs. (6,3 m. kg.).

Apply a small amount of “Loctite 30516 Aviation Gasket Sealant” or equivalent compound to the O.D. of the seal retainer and carefully press this assembly into the bore of the intermediate until fully seated. Clean any residual aviation cement off of the seal retainer and intermediate.

Apply a drop of water or light oil on the seal face of the stationary element; **never** use grease.

Subassemble the rotating element into the rotating seat. Apply a small amount of light oil to the O.D. of the rotating seat and press this assembly into the impeller until fully seated.

#### Impeller Installation

Inspect the impeller, and replace it if cracked or badly worn. Install the same thickness of impeller shims (14) as previously removed. Install the im-



PELLER key (4) and slide the impeller onto the shaft, taking care not to damage the sealing elements.

Install a new impeller O-ring (13). Insert a large screwdriver in the slot in the end of the motor shaft to prevent shaft rotation. Install the impeller screw (16) to 15 to 20 in. lbs. (1,7 to 2,3 m. kg.).

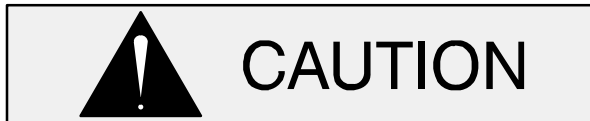

The vane plate (17) will seat properly in only one position; **do not** try to force the vane plate onto the intermediate alignment pins.

A clearance of .008 to .015 inch ( 0,30 to 0,38 mm) between the impeller and the vane plate (17) is necessary for maximum pump efficiency. Position the vane plate over the impeller and the alignment pins on the intermediate. The vane plate will seat properly in only one position; **do not** try to force the vane plate onto the intermediate alignment pins.

Use a feeler gauge to measure this clearance. Add or remove impeller shims until the proper clearance is achieved.

#### Vane Plate and Pump Casing Installation



Follow all torque recommendations when securing the pump hardware. Over-tightening can cause pump components to crack or threads to strip.

If the flow guide (21) was removed at disassembly, install a new flow guide O-ring (20) and secure the

flow guide to the pump casing (1) by torquing the self-tapping screws (22) in an alternating pattern to 8 to 10 ft. lbs. (0,9 to 1,1 m. kg.).

Install the vane plate O-ring (18) and the pump casing O-ring (5). Position the vane plate over the impeller and the alignment pins on the intermediate. Check impeller-to-vane plate clearance as described in **Impeller Installation**.

Carefully slide the pump casing over the vane plate and secure it to the intermediate by torquing the self-tapping screws (6) in an alternating pattern to 15 to 20 in. lbs. (1,7 to 2,3 m. kg.).

Install the capscrews and nuts (14 and 15) and torque them in an alternating pattern to 20 to 25 in. lbs. (2,3 to 2,9 m. kg.).

#### Final Pump Assembly

**Be sure** the pump and motor are securely mounted to the base.

Install the suction and discharge lines and open all valves. Make certain that all piping connections are tight, properly supported and secure.

Fill the pump casing with clean liquid.

Refer to **OPERATION**, Section C, before putting the pump back into service.

#### LUBRICATION

##### Seal Assembly

The seal assembly is lubricated by the medium being pumped. No additional lubrication is required.

**For U.S. and International Warranty Information,  
Please Visit [www.grpumps.com/warranty](http://www.grpumps.com/warranty)  
or call:  
U.S.: 419-755-1280  
International: +1-419-755-1352**

**For Canadian Warranty Information,  
Please Visit [www.grcanada.com/warranty](http://www.grcanada.com/warranty)  
or call:  
519-631-2870**