

**GHA SERIES
 EXTREME DUTY ABRASIVE
 G, J, N, R & S HYD SIZE
 ROTARY GEAR PUMP**



The GHA series is designed for applications in the operating ranges noted below. These units are available with head and backhead jackets for temperature control, and packing or carbide mechanical seal options described on the following pages.

This abrasive handling, extreme duty series, provides superior wear resistance. The design also provides superior rotor shaft support and an integral, maintenance-free radial/thrust bearing for reduced deflection and wear. Reduced speeds enable service over extended periods. Information such as percentage, size and hardness of solids present in the liquid are useful to estimate pump life.

FEATURES

- HARDENED, WEAR RESISTANT GEARS, HOUSING, HEAD, PIN, AND BUSHING*
- HARD FACE, WEAR RESISTANT MECHANICAL SEAL*
- OVERSIZED TAPERED SEAL CAVITY*
- HEAVY DUTY NEEDLE ROLLER BEARING*
- ROTOR END CLEARANCE EXTERNALLY ADJUSTABLE*
- FLEXIBLE SEAL DESIGN ALLOWS FOR A VARIETY OF INDUSTRY STANDARD SEALS OR PACKING*
- BALL BEARING THRUST CONTROL*

OPERATING RANGE

CAPACITY	(GPM) :	(8 TO 325)
	[LPM] :	[25 TO 1020]
PRESSURE	(PSI) :	[0 TO 200]
	[BAR] :	[0 TO 14]
VISCOSITY	(SSU) :	(28 TO 250,000)
	[cSt] :	[1 TO 55,000]
TEMPERATURE	(F) :	(-60° TO 500°)
	[C] :	[-51° TO 260°]

APPLICATIONS

- USE WITH ANY LIQUID COMPATIBLE WITH CAST IRON
- ★ PAINTS
- ★ INKS
- ★ ADHESIVES
- ★ WASTE LIQUIDS
- ★ EMULSIONS
- ★ FILTERING

EXTER- IOR	ROTOR & IDLER	HSG PORTS	IDLER BUSHING	BACKHD BEARING	IDLER PIN	SHAFT	SHAFT SEALING		ROTA- TION	INTERNAL RELIEF VALVE	
							MECHANICAL SEAL ●	PACKING ■		MATERIAL	SETTING
CAST IRON	HARD IRON	90° TAPPED/ FLNG'D	SILICON CARBIDE	① NEEDLE BEARING	TUNGSTEN CARBIDE	HARD. STEEL	SILICON CARB. SILICON CARB. VITON	ARAMID FIBER W/GRAPHITE	C.W.	DUCTILE IRON	75 PSI [5 BAR]

Standard Models

G H A 2 NK 3 - B
 | | | | | | |
 GEAR DUTY DESIGN PORT SIZE HYDRAULIC SEAL STYLE
 SIZE SIZE

MODEL NUMBER	NOM. CAPACITY-SPEED		MAXIMUM				SHIPPING DATA		
	MAXIMUM		DIFFERENTIAL PRESSURE - PSI [BAR]			TEMP.	② Weight	Volume	
	GPM [LPM]	RPM 60 Hz [50 HZ]	BELOW 38 SSU [4 cSt]	38 TO 100 SSU [21 cSt]	100 TO 250,000 SSU [55,000 cSt]	°F [°C]			LBS [KG]
GHA 1-1/2 GC 3-B ● GHA 1-1/2 GC 4-B ■	8 [25]	870 [720]					● 250 [119]	57 [25,9]	2.9
GHA 1-1/2 GF 3-B ● GHA 1-1/2 GF 4-B ■	11 [36]							57 [25,9]	
GHA 1-1/2 GH 3-B ● GHA 1-1/2 GH 4-B ■	15 [49]							57 [25,9]	
GHA 1-1/2 GJ 3-B ● GHA 1-1/2 GJ 4-B ■	19 [60]							57 [25,9]	
GHA 2 JJ 3-B ● GHA 2 JJ 4-B ■	28 [88]	580 [480]	100 [7]	150 [10]	200 [14]	● 250 [119]	144 [65,5]	144 [65,5]	5.3
GHA 2 JL 3-B ● GHA 2 JL 4-B ■	38 [121]							144 [65,5]	
GHA 2 JP 3-B ● GHA 2 JP 4-B ■	54 [169]							144 [65,5]	
GHA 2 NK 3-B ● GHA 2 NK 4-B ■	60 [188]	580 [480]	100 [7]	150 [10]	200 [14]	■ 500 [260]	180 [81,6]	180 [81,6]	5.3
GHA 3 NK 3-B ● GHA 3 NK 4-B ■								180 [81,6]	
GHA 2 NM 3-B ● GHA 2 NM 4-B ■	80 [251]							180 [81,6]	
GHA 3 NM 3-B ● GHA 3 NM 4-B ■								180 [81,6]	
GHA 2 NP 3-B ● GHA 2 NP 4-B ■	99 [313]							180 [81,6]	
GHA 3 NP 3-B ● GHA 3 NP 4-B ■								180 [81,6]	

STANDARD MODELS CONT.

① EXCEPT "S" SIZE AND 4-B MODELS (SILICON CARBIDE BUSHING).

② FOR 4-B UNIT WEIGHT, REFER TO GHS SECTION

● MECHANICAL SEAL
■ PACKING

THE GORMAN-RUPP COMPANY • MANSFIELD, OHIO
GORMAN-RUPP OF CANADA LIMITED • ST. THOMAS, ONTARIO, CANADA

MODEL NUMBER	NOM. CAPACITY-SPEED		MAXIMUM				SHIPPING DATA		
	MAXIMUM		DIFFERENTIAL PRESSURE - PSI [BAR]			TEMP.	Weight	Volume	
	GPM [LPM]	RPM 60 Hz [50 HZ]	BELOW 38 SSU [4 cSt]	38 TO 100 SSU [21 cSt]	100 TO 250,000 SSU [55,000 cSt]	°F [°C]	LBS [KG]	CU. FT.	
GHA 2 RM 3-B ● GHA 2 RM 4-B ■	85 [271]	350 [290]	100 [7]	150 [10]	200 [14]	● 250 [119] ■ 500 [260]	357 [162]	10.7	
GHA 2-1/2 RM 3-B ● GHA 2-1/2 RM 4-B ■							357 [162]		
GHA 3 RM 3-B ● GHA 3 RM 4-B ■							357 [162]		
GHA 3 RP 3-B ● GHA 3 RP 4-B ■							105 [339]		357 [162]
GHA 3 RR 3-B ● GHA 3 RR 4-B ■							125 [402]		357 [162]
GHA 3 RS 3-B ● GHA 3 RS 4-B ■							146 [465]		357 [162]
GHA 4 RS 3-B ● GHA 4 RS 4-B ■							146 [465]		357 [162]
GHA 3 SR 3-B ● GHA 3 SR 4-B ■	210 [660]	350 [290]	100 [7]	150 [10]	200 [14]	● 400 [204] ■ 500 [260]	530 [240]	17.3	
GHA 4 SR 3-B ● GHA 4 SR 4-B ■							530 [240]		
GHA 3 SU 3-B ● GHA 3 SU 4-B ■							325 [1020]		530 [240]
GHA 4 SU 3-B ● GHA 4 SU 4-B ■									530 [240]

■ PORTS ARE COMPATIBLE WITH 125# ANSI CAST IRON FLANGES. ALL OTHER PORTS ARE TAPPED NPT FOR ANSI PIPE.

NOTE: PROPER PUMP APPLICATION REQUIRES CONSIDERATION OF ADDITIONAL FACTORS. PLEASE REVIEW APPLICATION GUIDE IN SECTION 500 OR CONSULT THE FACTORY.

GHA

**FOR GHA DRIVE OPTIONS
AND DIMENSIONS**

SEE

SECTION 545



PERFORMANCE CURVES

SPEED VS. CAPACITY/HORSEPOWER

SR

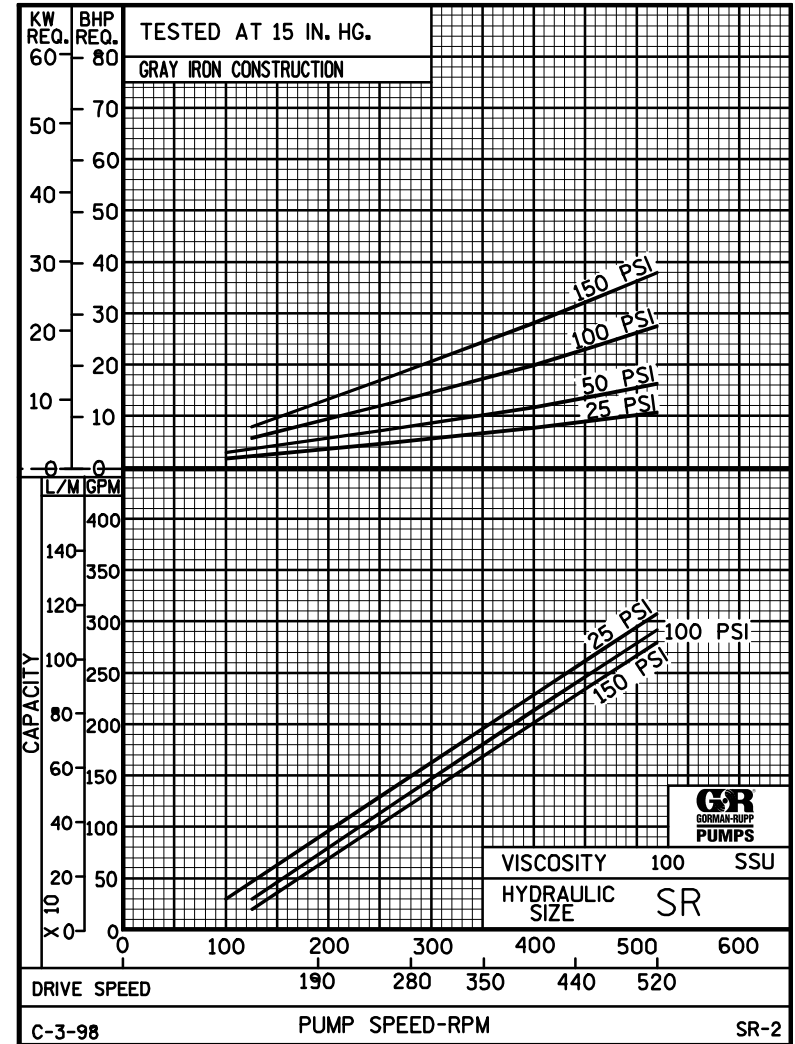
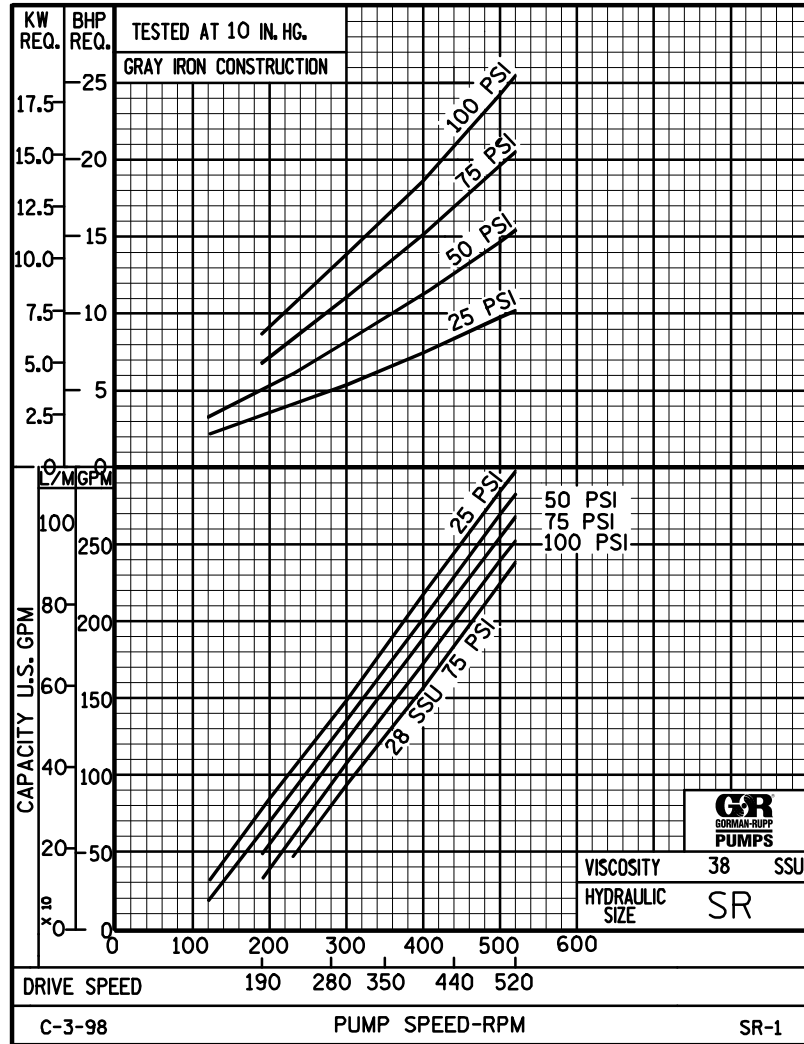
 Hydraulic Size

THE GORMAN-RUPP COMPANY • MANSFIELD, OHIO
 GORMAN-RUPP OF CANADA LIMITED • ST. THOMAS, ONTARIO, CANADA

Printed in U.S.A.

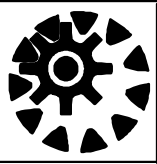

PERFORMANCE CURVES

SPEED VS. CAPACITY/HORSEPOWER

SR

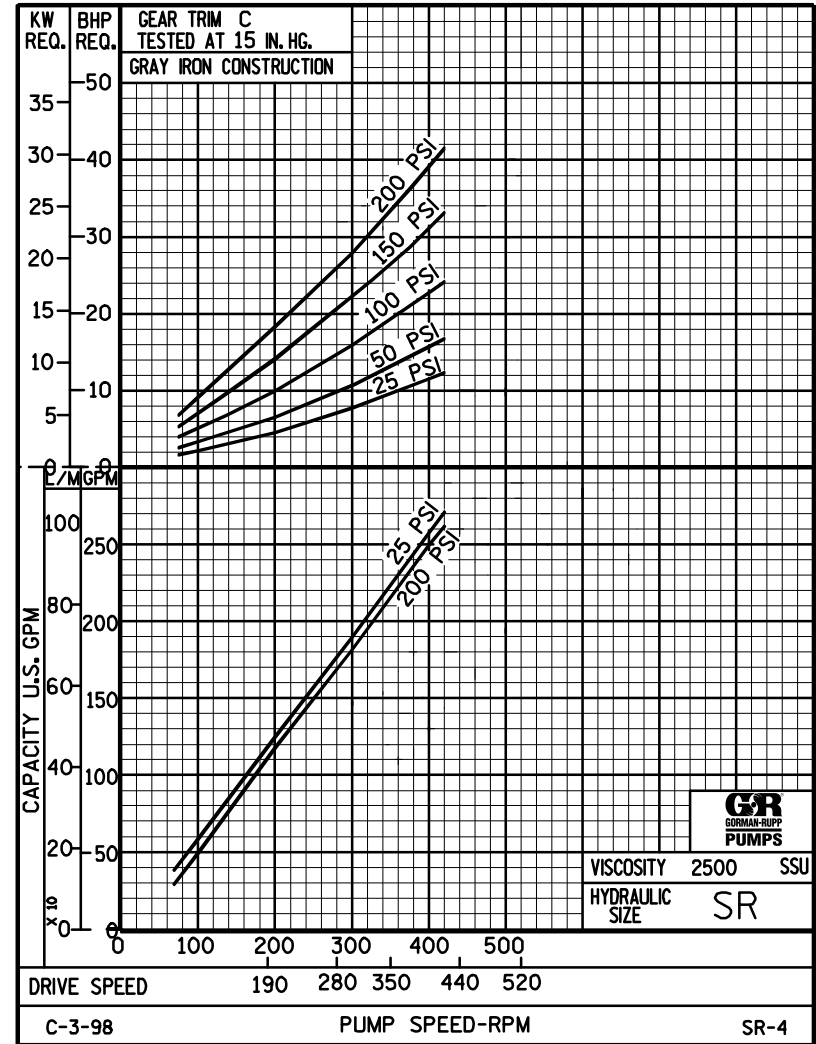
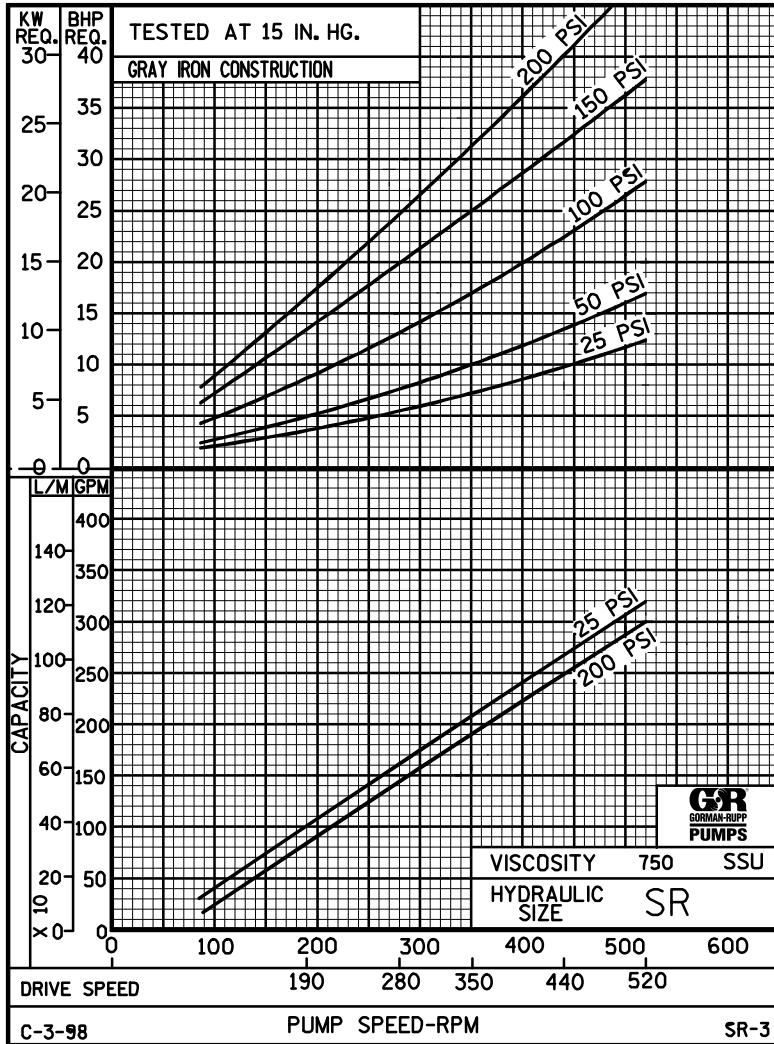
 Hydraulic Size

THE GORMAN-RUPP COMPANY • MANSFIELD, OHIO
 GORMAN-RUPP OF CANADA LIMITED • ST. THOMAS, ONTARIO, CANADA



PERFORMANCE CURVES

SPEED VS. CAPACITY/HORSEPOWER

SR

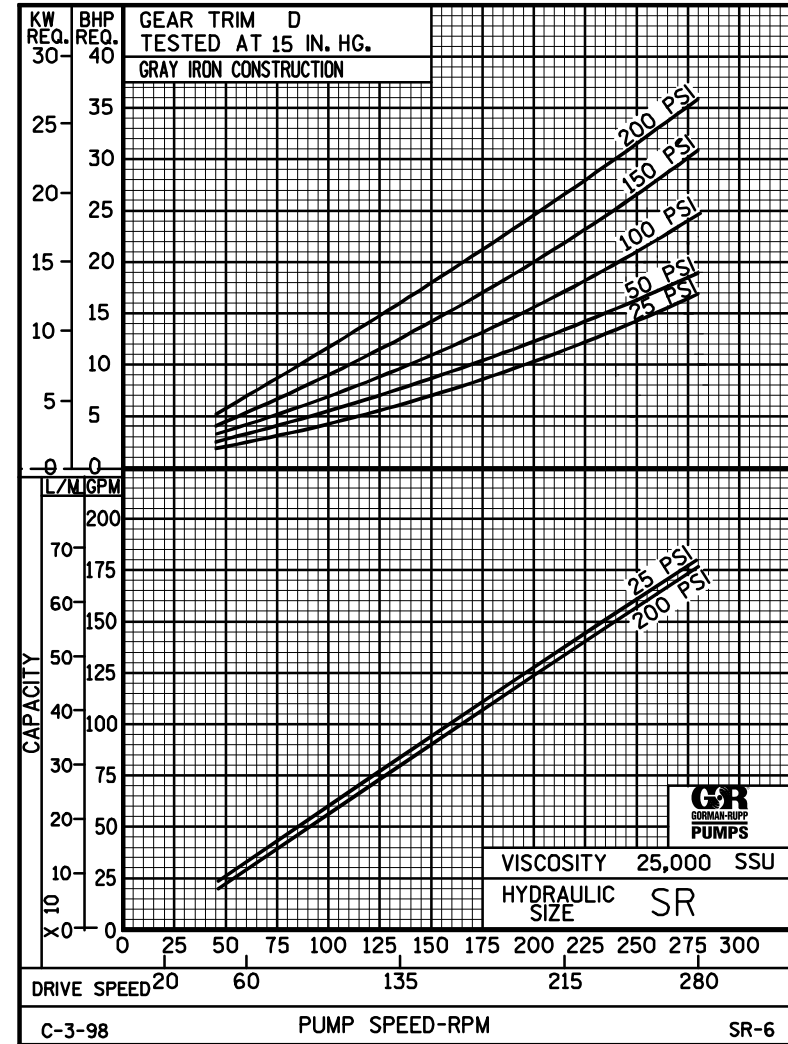
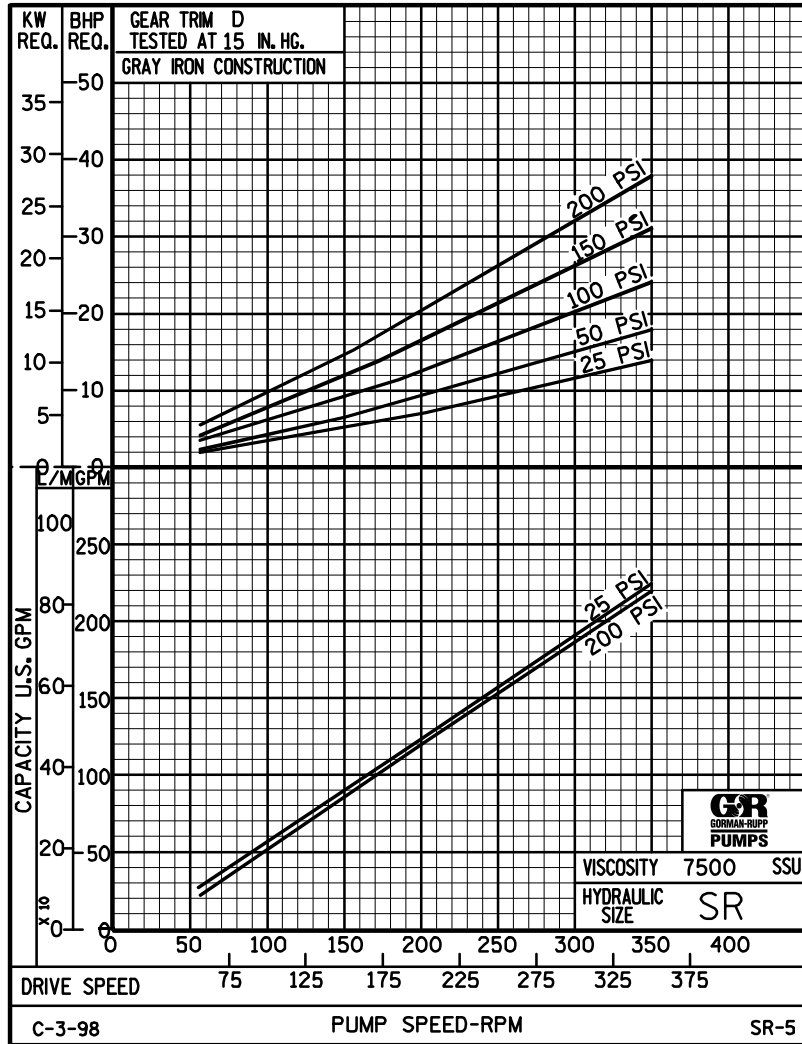
 Hydraulic Size

THE GORMAN-RUPP COMPANY • MANSFIELD, OHIO
GORMAN-RUPP OF CANADA LIMITED • ST. THOMAS, ONTARIO, CANADA

Printed in U.S.A.

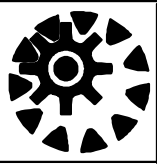

PERFORMANCE CURVES

SPEED VS. CAPACITY/HORSEPOWER

SR

Hydraulic Size

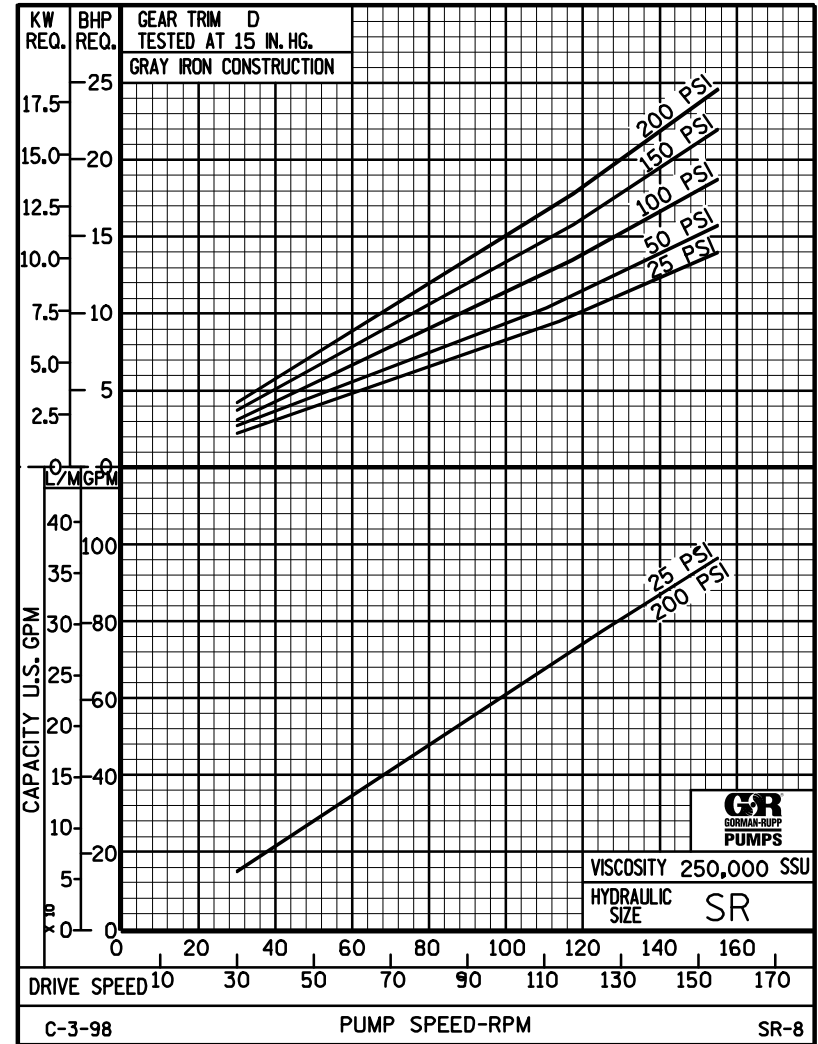
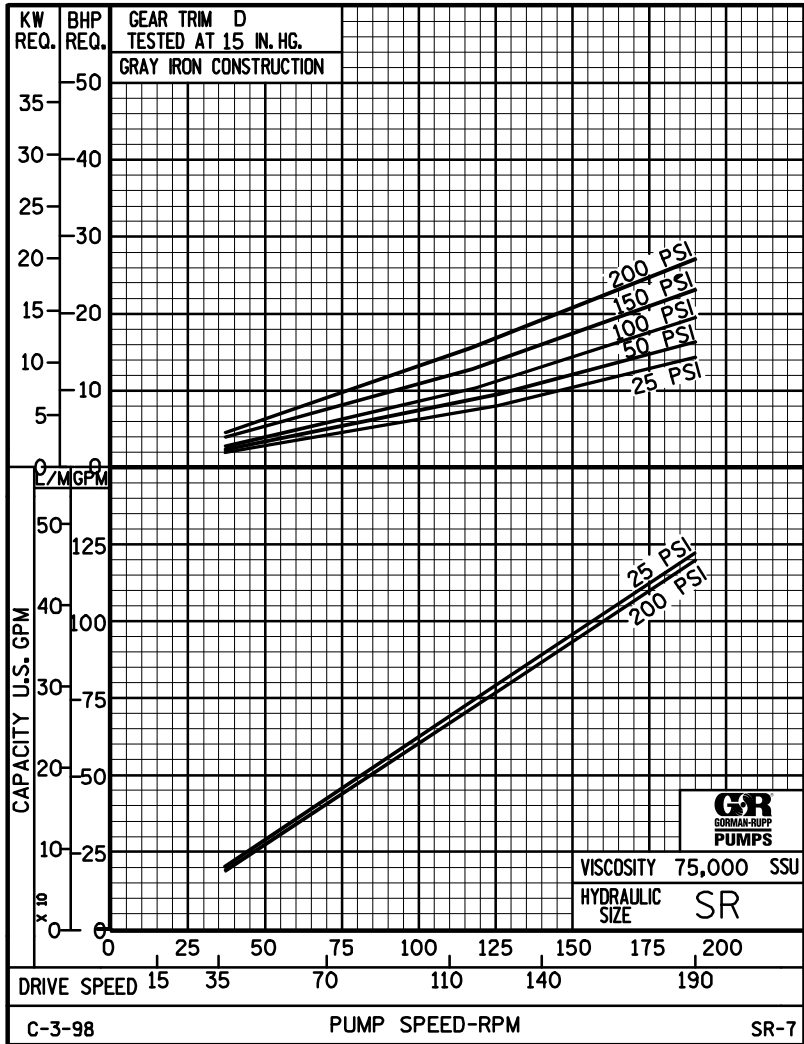

THE GORMAN-RUPP COMPANY • MANSFIELD, OHIO
GORMAN-RUPP OF CANADA LIMITED • ST. THOMAS, ONTARIO, CANADA

Printed in U.S.A.